

# Jake Sales

# Product Catalog

[www.jakesales.com](http://www.jakesales.com)

**Jake Sales**

[www.jakesales.com](http://www.jakesales.com)



# Jake Sales

## COMPANY OVERVIEW

Whether home owner or business owner, we have what you need.

We are **Jake Sales** (a division of **Totoly Jake Inc**), an online fulfillment company specializing in high quality fencing hardware, fasteners, and roofing products.

We are located in beautiful Kalispell, MT, within a short driving distance of Glacier National Park.

For over fifteen years, the business owner, Tom Hiseler, owned and ran a fencing company that worked throughout Flathead Valley and even as far away as North

Dakota during the oil boom. When he started Jake Sales in 2014, he quickly found a niche providing both fencing companies and home owners with high quality fencing hardware at a reasonable price.

## Mission Statement

To sell high quality products at a reasonable price and to meet the fastener fence hardware needs of businesses and DIYers everywhere.

The business quickly expanded into fasteners and

roofing products, and has seen consistent growth every year. We maintain a five-star rating from our website customers, and across all of our marketplaces, and we pride ourselves on going the extra mile to take care of you.

All of our products are designed to our high standards and are designed for commercial, residential, and industrial usage. Orders ship from our warehouse in Kalispell, MT, where we have tens of thousands of items stocked and ready to go out. We ship the same day for orders received before noon MST. All other in-stock orders go out the next business day.

For God so loved the world, that he gave his only begotten Son, that whosoever believeth in him should not perish, but have everlasting life. ~ John 3:16







# TABLE OF CONTENTS

 **Color / Painted Metal Roofing Screws ..... Page 4**

 **Construction Wood & Metal Screws ..... Page 12**

 **Vinyl Gate Hardware & Post Cap ..... Page 51**

 **Wood Fence Adapter & Gate Hardware ... Page 60**



 **Dektite Pipe Boot Roof Flashing ..... Page 67**

 **Chain Link Fence Hardware ..... Page 78**

 **Wrought Iron Fence Cap ..... Page 106**

 **Screw Bits, Drivers, Holders & Adapters .. Page 107**

 **Nails (Collated or Hand-Drive) ..... Page 117**



# COLOR / PAINTED METAL ROOFING / SIDING SCREWS



## #10 Metal Roofing Screws (Hex EPDM Washer Head)

SIZE	QUANTITY	DRIVE
#10 x 1"	250 COUNT	1/4" HEX
#10 x 1-1/2"	250 COUNT	1/4" HEX
#10 x 2"	250 COUNT	1/4" HEX
#10 x 2-1/2"	250 COUNT	1/4" HEX
#10 x 3"	250 COUNT	1/4" HEX

## #14 Metal Roofing Screws (Hex EPDM Washer Head)

SIZE	QUANTITY	DRIVE
#14 x 1"	250 COUNT	5/16" HEX
#14 x 1-1/2"	250 COUNT	5/16" HEX
#14 x 2"	250 COUNT	5/16" HEX
#14 x 2-1/2"	250 COUNT	5/16" HEX

Discounts apply to any purchase of three (3) + of this product in course of the same order.

- Order 3 or more Metal Roofing/Siding Screws or other Bulk Metal Screws - **Save 8%**
- Order 10 or more Metal Roofing/Siding Screws or other Bulk Metal Screws - **Save 12%**
- Order 50 or more Metal Roofing/Siding Screws or other Bulk Metal Screws - **Save 25%**
- Order 240 (1/2 Pallet/24 Boxes) of 250 COUNT #10 X 1 inch Metal to Wood Roofing Screws Quantity - **Save 30%**
- Order 480 (Full Pallet/48 Boxes) of 250 COUNT #10 X 1 inch Metal to Wood Roofing Screws Quantity - **Save 35%**

- These screws have under gone 1,000 hours of salt spray testing
- They have a type 17 point for fast starts while virtually eliminating walking
- Screw Head Available in Galvanized/Zinc and many different colors
- These are metal to wood screws self-piercing metal roofing and siding screws
- They have an EPDM washer to prevent leaking
- Great for pole barn and all metal roofing & siding applications
- These colored metal roofing screws have been painted with a high quality two part polyurethane paint
- You will need to use a 1/4" Nut Driver for Installation
- For a rough calculation figure 80 screws per 10' x 10' section of roofing
- ONLY screw head is painted to ensure EPDM washer seals to metal roof. NO paint on the threads to maximize holding strength
- See our roofing screw cross reference drop-down menus to help you choose your color.
- NOTE: Please keep in mind when choosing the screw color to match your roofing that due to differences in computer screens, in sheet metal roofing production runs, and roofing screw production runs, the color you order and the color of your roofing may vary to some degree

## AVAILABLE COLORS

ABC GRAY
ANTIQUE BRONZE
ASH GRAY
BLACK
BONEWHITE
BRITE WHITE
BROWN
BUCKSKIN
BURGUNDY
CHARCOAL

CLAY
COLONIAL RED
COPPER
CRIMSON RED
DARK BLUE
DARK BRONZE
DARK BROWN
DARK RED
EVERGREEN
FAB CHARCOAL

GALLERY BLUE
HARTFORD GREEN
HEMLOCK GREEN
HERON BLUE
IVORY
IVY GREEN
LIGHT BROWN
LIGHT GRAY
LIGHT STONE
MANSARD BROWN

OCEAN BLUE
OLD TOWN GRAY
PATINA GREEN
PEWTER GRAY
RED
SLATE
SLATE BLUE
SURREY BEIGE
TAN
NO PAINT



# COLOR / PAINTED METAL ROOFING / SIDING SCREWS

## #10 Mini Driller Metal Roofing Screws (Hex EPDM Washer Head)

SIZE	QUANTITY	DRIVE
#10 x 1"	250 COUNT	1/4" HEX
#10 x 1-1/2"	250 COUNT	1/4" HEX
#10 x 2"	250 COUNT	1/4" HEX
#10 x 2-1/2"	250 COUNT	1/4" HEX



Discounts apply to any purchase of three (3) + of this product in course of the same order.

- Order 3 or more Metal Roofing/Siding Screws or other Bulk Metal Screws - **Save 8%**
- Order 10 or more Metal Roofing/Siding Screws or other Bulk Metal Screws - **Save 12%**

- Metal-to-Wood roofing screws have a Mini-Drilling Tip for faster start times.
- The color on the roof screw heads is painted with a two part polyurethane for longer product life.
- Increased performance when drilling through two layers of metal roofing, reduces shavings
- Hi-Lo thread provides superior pull out strength in Metal to Wood applications.  
1/2 EPDM Washer
- Corrosion resistance - over 1,000 hour salt spray tested without failures. Sturdy and reliable
- These self starting roofing screws help take the headache out of sheet metal roof and siding installation
- EPDM washer seal, seals roofing panel to screws.

### Use 1/4" Nut Driver for Installation

- These metal-to-wood screws are great sheet metal roofing screws to use on any metal roofing or siding project
- For installing roofing on a house, porch, airplane hangar, shed, pole barn, shop, barn or lean-to.
- For a rough calculation figure 80 screws per 10' x 10' section of roofing
- **ONLY** screw head is painted to ensure EPDM washer seals to metal roof. **NO**

paint on the threads to maximize holding strength

- **NOTE:** Please keep in mind when choosing the screw color to best match your roofing that due to differences in computer screens, sheet metal roofing production, and roofing screw production the color you order and the color of your roofing may vary to some degree.

**Zinc Screws Are In Stock - Will Ship Within 24 Hours. Subject to normal return and refund policy.**

**All Other Colors Are Special Order - All Purchases are Final No Cancellations Once Order is Placed - No Refunds Please Call for Current Shipping Times (406) 752-5253.**





# COLOR / PAINTED METAL ROOFING / SIDING SCREWS



## #12 Metal Roofing Screws (REG RIP)

SIZE	QUANTITY	DRIVE
#12 x 1-1/2"	250 COUNT	1/4" HEX
#12 x 2"	250 COUNT	1/4" HEX
#12 x 2-1/2"	250 COUNT	1/4" HEX

Discounts apply to any purchase of three (3) + of this product in course of the same order.

- Order 3 or more Metal Roofing / Siding Screws - **Save 8%**
- Order 10 or more Metal Roofing / Siding Screws - **Save 12%**



- ReGrip Screws are designed to replace screws or nails that have failed
- These screws have a **1/4" hex head** for easy installation.
- The screw has an oversized 5/8" EPDM washer to seal tight to roof panels.
- These sharp point screws drill into the metal and wood easily.
- Metal-to-wood roofing screws are painted with two part polyurethane for long life.
- These metal-to-wood screws are great sheet metal roofing screws to use on any metal roofing or siding project
- For installing roofing on a house, porch, airplane hangar, shed, pole barn, shop, barn or lean-to.
- **ONLY** screw head is painted to ensure EPDM washer seals to metal roof. **NO** paint on the threads to maximize holding strength

- **NOTE:** Please keep in mind when choosing the screw color to match your roofing that due to differences in computer screens, in sheet metal roofing production, and roofing screw production, the color you order and the color of your roofing may vary to some degree.

**NOTE:** Galvanized/Zinc Screws are not painted. Gray color is a naturally occurring color from the galvanizing process

**Available In:** \* ABC Gray, \*Black, \*Brite White, \*Brown, \*Burgundy, \*Charcoal, \*Crimson Red, \*Dark Bronze, \*Dark Brown, \*Evergreen, \*Light Gray, \* Light Stone, \*Red, \*Zinc

**All other colors are special order.**

**Please Call for Current Shipping Times (406) 752-5253**





# COLOR / PAINTED METAL ROOFING / SIDING SCREWS

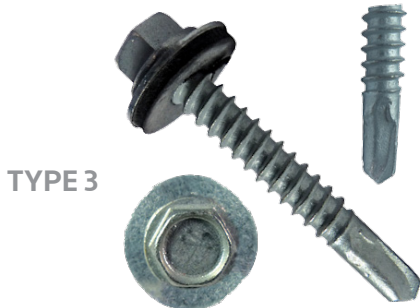

TYPE 3

## #12 Metal to Metal Roofing Screws (Hex Head with EPDM Washer)

	SIZE	QUANTITY	DRIVE
Type 3	1-1/2"	250 COUNT	5/16" HEX
Type 5	1-1/2"	250 COUNT	5/16" HEX

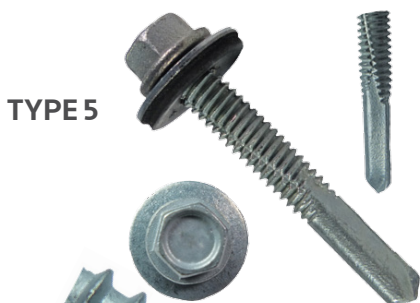

TYPE 5

Discounts apply to any purchase of three (3)+ of this product in course of the same order.

- Order 3 or more Metal Roofing/Siding Screws or other Bulk Metal Screws - **Save 8%**
- Order 10 or more Metal Roofing/Siding Screws or other Bulk Metal Screws - **Save 12%**



**TYPE 3 x 1-1/2"**

- Coarse Threaded Type 3 Screws generally used in thinner or lighter steel or aluminum products
- The #12 x 1-1/2" Screw Has a Maximum Material Thickness of 3/4" with a 1/2" Drill Tip

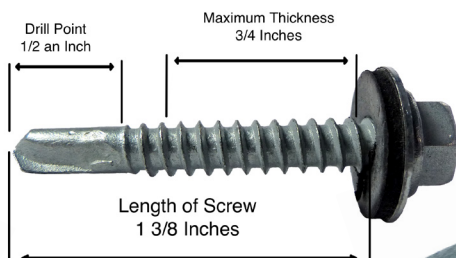

**TYPE 5 x 1-1/2"**

- Fine Threaded Type 5 Screws are designed to work in thicker materials rated from for 3/8" to 1/2"
- The #12 x 1-1/2" Screw Has a Maximum Material Thickness of 5/8" with a 5/8" Drill Tip

- Mechanical Galvanized Self Driller Type #5 Metal to Metal Roofing Screws have a 5/16" Hex Head with a 9/16" EPDM Washer
- Total overall length of the screw measured under the head is 1-3/8"
- The Galvanized/Zinc Screws are rust resistant having under gone over 1,000 hours of salt spray testing
- Self-Drill Type 5 Point will drill through metal roofing panel and into steel structure without pre-drilling
- The EPDM Washer is designed to seal the metal roofing panel to the screw to prevent leaking

- The 5/16" Hex Head provides a solid lock on the screw for easy installation
- For installing metal roofing or wall panels on steel frame buildings as in industrial, workshops, garages, commercial

**Some Colors Are Special Order - All Purchases are Final  
No Cancellations Once Order is Placed - No Refunds  
Please Call for Current Shipping Times (406) 752-5253**



# COLOR / PAINTED METAL ROOFING / SIDING SCREWS

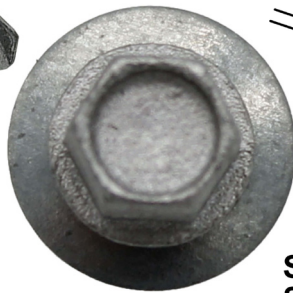

## #14 Stitch Tek Metal To Metal Type #1 Roofing Screws

SIZE	QUANTITY	DRIVE
#14 x 7/8"	250 COUNT	5/16" HEX

Discounts apply to any purchase of three (3) + of this product in course of the same order.

- Order 3 or more Metal Roofing/Siding Screws or other Bulk Metal Screws - Save 8%
- Order 10 or more Metal Roofing/Siding Screws or other Bulk Metal Screws - Save 12%

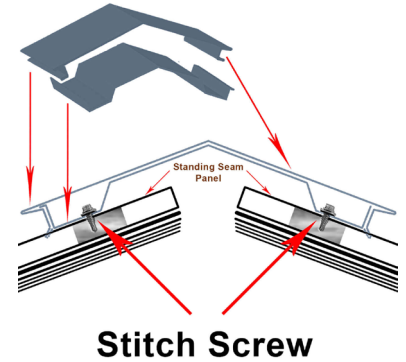
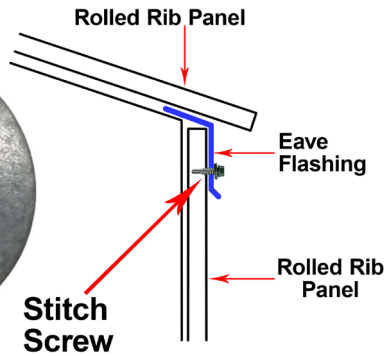

- Mechanical galvanized self drilling Type #1 Metal to Metal Stitching Screws have a 5/16" hex head with a 9/16" EPDM Washer
- The #14 x 7/8" Screw is used to attach metal to metal panels together
- Self drilling tip means no pre-drilling necessary eliminating steps needed to install
- The 9/16" EPDM washer is designed to seal the metal panel to the screw to prevent leaking
- The 5/16" hex head provides a solid grip on the screw for positive installation.
- Mechanical galvanized screws prevent corrosion and rusting.
- These screws have gone over 1,000 hours of salt spray testing without failure.
- Use for attaching corner and rake trims and the ridge cap where they overlap wall steel

**Only Black, Brite White, Brown, Charcoal, Evergreen, Ivy Green and No Paint Screws are available at this time - All other colors are special order. Please Call for Current Shipping Times (406) 752-5253**

## Check with Us First



[www.jake-sales.com](http://www.jake-sales.com)



# COLOR / PAINTED METAL ROOFING / SIDING SCREWS



## #10 Low Profile Pancake Head - Wood to Metal Roofing Screws

SIZE	QUANTITY	DRIVE
#10 x 1"	250 COUNT	#2 Square Head
#10 x 1-1/2"	250 COUNT	#2 Square Head
#10 x 2"	250 COUNT	#2 Square Head

Discounts apply to any purchase of three (3) + of this product in course of the same order.

- Order 3 or more Pancake Low Profile Roofing Screw - Save 8%
- Order 10 or more Pancake Low Profile Low Profile Roofing Screw - Save 12%

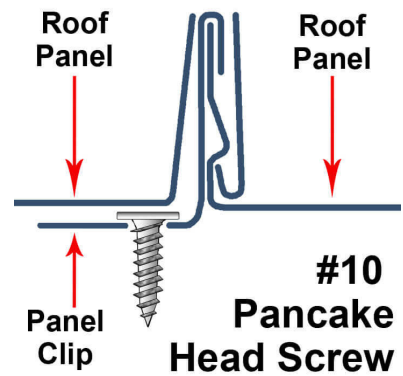
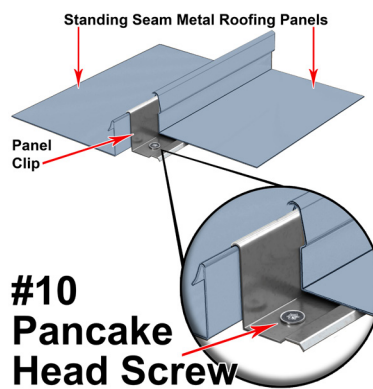

- Ultra-thin flush finish pancake head fastener for Metal to Wood Standing Seam Roofing Applications
- This low profile pancake head fastener has a sharp point tip to easily push through pre-drilled metal panels for easy installation
- Designed with a low, thin profile to hold standing seam clips in place while laying flush
- Unlike thicker pancake head screws these screws lay flat, and if installed correctly, will not pimple or show through the roofing panel
- Screws have a Zinc coating to prevent rusting and corrosion
- Use these screws with a #2 Square Head Drive Bit.

**HAVE QUESTIONS?  
NEED ANSWERS?**

E-mail: [tom@jakesales.com](mailto:tom@jakesales.com)

Phone: (406) 752-5253

Website: [jakesales.com](http://jakesales.com)

# Jake Sales

[www.jakesales.com](http://www.jakesales.com)

# COLOR / PAINTED METAL ROOFING / SIDING SCREWS

## #9 *Stainless Steel* Sheet Metal Roofing Screws

SIZE	QUANTITY	DRIVE
#9 x 1"	250 COUNT	1/4" HEX
#9 x 1-1/2"	250 COUNT	1/4" HEX
#9 x 2"	250 COUNT	1/4" HEX
#9 x 2-1/2"	250 COUNT	1/4" HEX

Discounts apply to any purchase of three (3)+ of this product in course of the same order.

- Order 3 or more Metal Roofing/Siding Screws and Save 8%
- Order 10 or more Metal Roofing/Siding Screws and Save 12%



- These Self-Piercing tipped roofing screws help take the headache out of sheet metal roof and siding installation
- Colored screw head (when applicable) is painted with a two part polyurethane paint.
- Self-Piercing screws are used to push through pre-drilled sheet metal panels for easier installation
- Stainless Steel screws are the ultimate in corrosion resistance in high humidity areas.
- Plus these Stainless Steel Screws are back by a 50 Year Manufacturer Warranty against manufacturing defects
- These screws have a 1/4 Inch Hex Screw Head for easy driving
- The 1/2" EPDM washer seals roofing panel to screws to prevent leaking.
- These stainless steel metal-to-wood screws can be used on any metal roofing or siding project
- For Installing roofing on a house, porch, airplane hangar, shed, pole barn, shop or barn

**All colors are special order. Please Call for Current Shipping Times (406) 752-5253. All Purchases are Final  
No Cancellations Once Order is Placed - No Refunds**



# COLOR / PAINTED METAL ROOFING / SIDING SCREWS



## #12 *Stainless Steel* ReGrip Roofing Screws

SIZE	QUANTITY	DRIVE
#12 x 1-1/2"	250 COUNT	1/4" HEX
#12 x 2"	250 COUNT	1/4" HEX
#12 x 2-1/2"	250 COUNT	1/4" HEX

Discounts apply to any purchase of three (3)+ of this product in course of the same order.

- Order 3 or more Metal Roofing/Siding Screws or other Bulk Metal Screws - Save 8%
- Order 10 or more Metal Roofing/Siding Screws or other Bulk Metal Screws - Save 12%

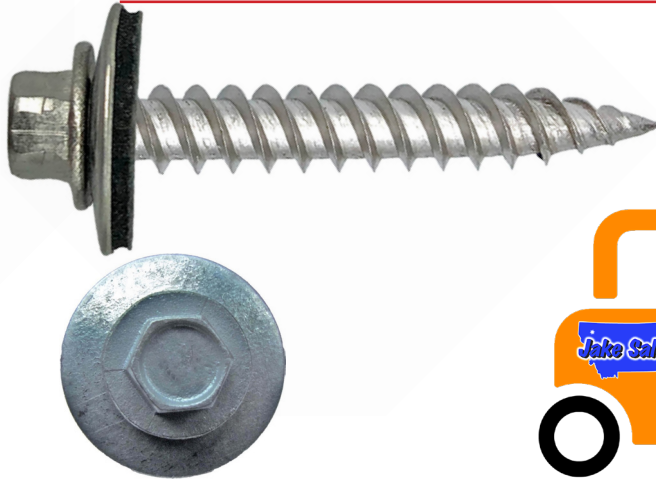

- Colored screw head (when applicable) is painted with a two part polyurethane paint.
- ReGrip Screws are designed to replace screws or nails that have failed
- Stainless Steel screws are the ultimate in corrosion resistance in high humidity areas.
- These screws have a 1/4 Inch Hex Screw Head for easy driving
- The oversized 5/8" EPDM washer seals roofing panel to screws to prevent leaking.
- These stainless steel metal-to-wood screws can be used for any metal roofing or siding project
- For Installing roofing on a house, porch, airplane hangar, shed, pole barn, shop or barn

**All colors are special order. Please Call for Current Shipping Times (406) 752-5253. All Purchases are Final  
No Cancellations Once Order is Placed - No Refunds**

# CONSTRUCTION WOOD & METAL SCREWS



## #7 Bronze Star Finish Head Screws (Tiny Head Screws)

SIZE	QUANTITY	DRIVE
#7 x 1-5/8"	1 POUND (~235 SCREWS)	T-10
#7 x 1-5/8"	5 POUNDS (~1175 SCREWS)	T-10
#7 x 1-5/8"	BULK BOX (5,500 COUNT)	T-10
#7 x 2"	1 POUND (~187 SCREWS)	T-10
#7 x 2"	5 POUNDS (~935 SCREWS)	T-10
#7 x 2"	BULK BOX (4,000 COUNT)	T-10
#7 x 2-1/2"	1 POUND (~141 SCREWS)	T-10
#7 x 2-1/2"	5 POUNDS (~705 SCREWS)	T-10
#7 x 2-1/2"	BULK BOX (3,000 COUNT)	T-10
#7 x 3"	1 POUND (~118 SCREWS)	T-10
#7 x 3"	5 POUNDS (~590 SCREWS)	T-10
#7 x 3"	BULK BOX (2,500 COUNT)	T-10



Discounts apply to any purchase of two + identical quantities (1 Pound, 5 Pounds or Bulk) in course of same order.

- Order 2 or More 1 Pound Finish Head Wood Screws or other Screws - **Save 15%**
- Order 6 of More 1 Pound Finish Head Wood Screws or other Screws - **Save 25%**
- Order 2 or More 5 Pound Finish Head Wood Screws or other Screws - **Save 10%**
- Order 6 of More 5 Pound Finish Head Wood Screws or other Screws - **Save 20%**
- Order 2 or more Finish Head Wood Screws or other Bulk Screw Boxes - **Save 5%**
- Order 6 or more Finish Head Wood Screws or other Bulk Screw Boxes - **Save 10%**



## DID YOU KNOW...?

Many fasteners have what is called a "Type 17 point", which is a small wedge cut out of one side of the point, reducing its starting size slightly and lessening the initial friction in order to help it to start screwing into wood with a vastly reduced chance of the wood splitting around the initial entry point. This also helps prevent the screw/fastener from "walking" around before it bites firmly into the material.

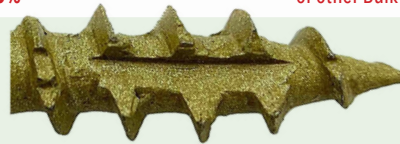

- High performance interior/exterior coated screws
- Finish "Tiny" Head Screws for professional operations & demanding industries
- Excellent screws for both hard and soft wood
- High quality heat treated steel self-countersinking screw head (0.20" Hhead diameter)
- Deep, wide, sharp screw threads provide maximum holding power
- High quality screw threads cut cleanly & easily through tough materials

- Knurled screw shoulder lowers drill torque requirements
- Type 17 notched screw point for quick starts without "walking"
- Torx/Star Drive delivers twice the torque of Phillips or Square Drive screws
- **Use with the T10 Driver Bit**
- Deep Torx/Star Drive Screws reduce "Cam-out"
- Excellent screw for siding trim, corner trim, log trim accents, etc.



# CONSTRUCTION WOOD & METAL SCREWS



## #10 x 1-1/4" Star/Torx Wafer Head Self Drilling Screw

QUANTITY	DRIVE
1 POUND	T-25
5 POUNDS	T-25
FULL BOX	T-25

Discounts apply to any purchase of two or more of the same size (1 Pound, 5 Pound or Bulk) boxes on the same order.

- Order 2 or More 1 Pound Self Drilling Wafer Head Screws or other Screws **Save 15%**
- Order 6 of More 5 Pound Self Drilling Tek Screws or other Screws **Save 20%**
- Order 2 or more Wood to Steel Tek Screws or other Bulk Screw Boxes **Save 5%**
- Order 6 or more Wood to Steel Tek Screws or other Bulk Screw Boxes **Save 10%**
- Order 2 or More 5 Pound Self Drilling Tek Screws or other Screws **Save 10%**
- Order 6 of More 1 Pound Self Drilling Wafer Head Screws or other Screws **Save 25%**



- Self Drilling/Tapping Screw, excellent screw for metal to metal or wood to metal applications
- For professional operations & demanding industries
- Zinc Plated to resist corrosion, high quality heat treated steel
- 7/16" Head Diameter, deep, wide, sharp screw threads provide maximum holding power
- High quality screw threads cut cleanly & easily through tough materials
- Drill point for easy installation
- Torx/Star Drive delivers twice the torque of Phillips or Square drive screws
- **Use with T25 Driver Bit**
- Deep Torx/Star Drive Screws reduce "Cam-out"

## Jake Sales

### CONTACT US

If there is anything we can assist you with, please feel free to call

**(406) 752-5253**

Mon-Fri, 8am-4pm, Mountain Time

# CONSTRUCTION WOOD & METAL SCREWS

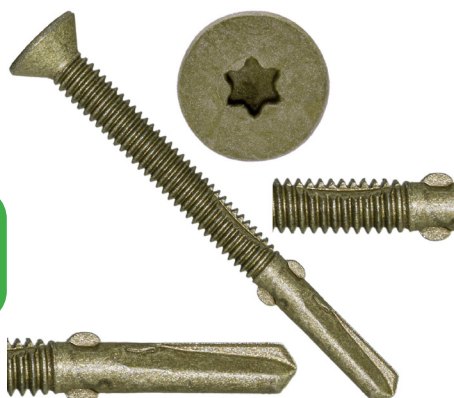

Reamer Tek  
Wings Snap Off  
Once Wood is  
Drilled Through  
and Steel is  
Contacted



## Self-Drilling Reamer Tek Wood to Metal Screws W/Reamer Wings

SIZE	QUANTITY	DRIVE
#10 x 1-5/8"	1 POUND (~113 COUNT)	T-25
#10 x 1-5/8"	5 POUNDS (~565 COUNT)	T-25
#10 x 1-5/8"	BULK BOX (4,000 COUNT)	T-25
#12 x 2"	1 POUND (~68 COUNT)	T-25
#12 x 2"	5 POUNDS (~340 COUNT)	T-25
#12 x 2"	BULK BOX (2,000 COUNT)	T-25
#12 x 2-1/2"	1 POUND (~55 COUNT)	T-25
#12 x 2-1/2"	5 POUNDS (~275 COUNT)	T-25
#12 x 2-1/2"	BULK BOX (2,500 COUNT)	T-25
#14 x 2-3/4"	1 POUND (~34 COUNT)	T-30
#14 x 2-3/4"	5 POUNDS (~170 COUNT)	T-30
#14 x 2-3/4"	BULK BOX (1,000 COUNT)	T-30
#14 x 3-1/4"	1 POUND (~30 COUNT)	T-30
#14 x 3-1/4"	5 POUNDS (~150 COUNT)	T-30
#14 x 3-1/4"	BULK BOX (1,000 COUNT)	T-30
#14 x 4"	1 POUND (~24 COUNT)	T-30
#14 x 4"	5 POUNDS (~118 COUNT)	T-30
#14 x 4"	BULK BOX (1,000 COUNT)	T-30

Discounts apply to any purchase of two or more of same size (1 Pound, 5 Pound or Bulk) boxes of same order.

- Order 2 or More 1 Pound Steel Tek Screws or other Screws - **Save 15%**
- Order 6 of More 1 Pound Steel Tek Screws or other Screws - **Save 25%**
- Order 2 or More 5 Pound Reamer Tek Screws or other Screws - **Save 10%**
- Order 6 of More 5 Pound Reamer Tek Screws or other Screws - **Save 20%**
- Order 2 or more Reamer Tek Screws or other Bulk Screw Boxes - **Save 5%**
- Order 6 or more Reamer Tek Screws or other Bulk Screw Boxes - **Save 10%**

- Reamer Tek Screws are engineered for applications where wood is being fastened to steel or aluminum
- Self-Drilling Wings will bore through wood and then break off once they contact the steel or aluminum
- Excellent Tek Screw for trailer decks, truck beds, docks, horse trailers, utility trailers, ATV trailers, etc.
- Reamer Tek Screws are manufactured from high quality head treated steel
- Reamer Tek Screws are coated with the

bronze star triple ceramic coating for superior exterior protection

- Coating has been through 1200 hours of salt spray testing without failures
- ACQ Pressure treated lumber compatible, corrosion resistant, for use in softwood or hardwood
- Deep, wide & sharp threads provide maximum holding power, no pre-drilling in most applications
- These high performance Tek Screws accomplish hard jobs in less time

• **Use Torx Bit T-25 for #10 & #12 Tek Screws and Torx Bit T-30 for #14 Tek Screws**

- Head diameters - .38" for #8 Tek Screws -- .42" for #12 Tek Screws -- .461" for #8 Tek Screws
- Torx/Star Drive delivers twice the torque of Phillips or Square drive Tek Screws
- Deep Torx/Star Drive Tek Screws reduce "cam-out"
- Countersinking head provides a neat and clean finished look



# CONSTRUCTION WOOD & METAL SCREWS

## #8 Gold Star "YTX" Heavy Duty Flat Head Wood Screws

SIZE	QUANTITY	DRIVE
#8 x 1"	1 POUND (~270 COUNT)	T-20
#8 x 1"	5 POUNDS (~1,350 COUNT)	T-20
#8 x 1"	BULK BOX (10,000 COUNT)	T-20
#8 x 1-1/4"	1 POUND (~225 COUNT)	T-20
#8 x 1-1/4"	5 POUNDS (~1,155 COUNT)	T-20
#8 x 1-1/4"	BULK BOX (9,000 COUNT)	T-20
#8 x 1-1/2"	1 POUND (~193 COUNT)	T-20
#8 x 1-1/2"	5 POUNDS (~980 COUNT)	T-20
#8 x 1-1/2"	BULK BOX (6,500 COUNT)	T-20
#8 x 1-3/4"	1 POUND (~165 COUNT)	T-20
#8 x 1-3/4"	5 POUNDS (~855 COUNT)	T-20
#8 x 1-3/4"	BULK BOX (4,000 COUNT)	T-20
#8 x 2"	1 POUND (~150 COUNT)	T-20
#8 x 2"	5 POUNDS (~745 COUNT)	T-20
#8 x 2"	BULK BOX (3,500 COUNT)	T-20
#8 x 2-1/2"	1 POUND (~120 COUNT)	T-20
#8 x 2-1/2"	5 POUNDS (~595 COUNT)	T-20
#8 x 2-1/2"	BULK BOX (2,500 COUNT)	T-20

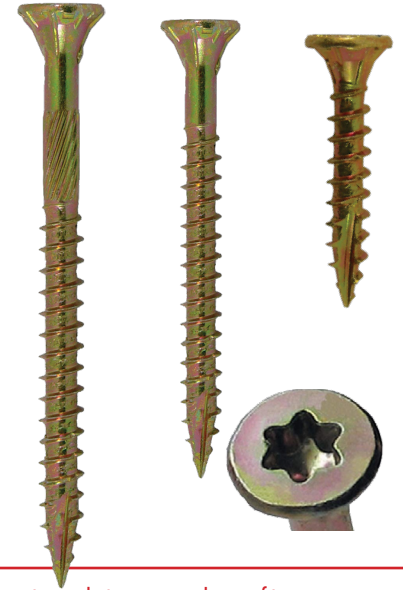

Discounts apply to any purchase of two + identical quantities (1 Pound, 5 Pound or Bulk) in course of same order.

- Order 2 or More 1 Pound Yellow Zinc Wood Screws or other Screws **Save 15%**
- Order 6 or More 1 Pound Yellow Zinc Wood Screws or other Screws **Save 25%**
- Order 2 or More 5 Pound Yellow Zinc Wood Screws or other Screws **Save 10%**
- Order 6 or More 5 Pound Yellow Zinc Wood Screws or other Screws **Save 20%**
- Order 2 or more #8 Yellow Zinc Wood Screws or other Bulk Screw Boxes **Save 5%**
- Order 6 or more #8 Yellow Zinc Wood Screws or other Bulk Screw Boxes **Save 10%**
- Order 24 (1/2 Pallet) or more Bulk Box Yellow Zinc Wood Screws **Save 15%**
- Order 48 (Full Pallet) or more Bulk Box Yellow Zinc Wood Screws **Save 20%**

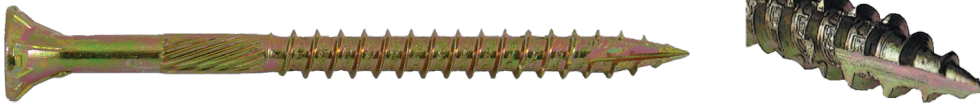

- General Purpose Yellow Zinc Triple Coated Screws, Excellent General Purpose Screws
- Manufactured from High Quality Heat Treated Steel
- For Professional Operations & Demanding Industries, Excellent Screws for Both Hard and Soft Wood
- Self-Countersinking Screw Head (0.32" Head Diameter)
- Deep, Wide, Sharp Screw Threads Provide Maximum Holding Power
- High Quality Screw Threads Cut Cleanly

- & Easily Through Tough Materials
- Knurled Screw Shoulder Lowers Drill Torque Requirements
- Type 17 Notched Screw Point for Quick Starts without "Walking"
- Torx/Star Drive Delivers Twice the Torque of Phillips or Square Drive Screws
- Deep Torx/Star Drive Screws Reduce "Cam-out"
- Excellent Screw for Cabinetry, Furniture, Roofing, Framing, etc.
- **Use with T20 Driver Bit**

### Screw Engineering Specs:

Average Shear Strength of 2213 lbs.  
Average Pull-Out Strength is 363 lbs (2" Length) (Specs in Yellow Pine Wood)



# CONSTRUCTION WOOD & METAL SCREWS



## #9 Gold Star "YTX" Heavy Duty Flat Head Wood Screws

SIZE	QUANTITY	DRIVE
#9 x 2"	1 POUND (~115 COUNT)	T-25
#9 x 2"	5 POUNDS (~570 COUNT)	T-25
#9 x 2"	BULK BOX (3,000 COUNT)	T-25
#9 x 2-1/2"	1 POUND (~90 COUNT)	T-25
#9 x 2-1/2"	5 POUNDS (~450 COUNT)	T-25
#9 x 2-1/2"	BULK BOX (2,500 COUNT)	T-25
#9 x 2-3/4"	1 POUND (~82 COUNT)	T-25
#9 x 2-3/4"	5 POUNDS (~410 COUNT)	T-25
#9 x 2-3/4"	BULK BOX (2,000 COUNT)	T-25
#9 x 3"	1 POUND (~75 COUNT)	T-25
#9 x 3"	5 POUNDS (~375 COUNT)	T-25
#9 x 3"	BULK BOX (2,000 COUNT)	T-25
#9 x 3-1/8"	1 POUND (~72 COUNT)	T-25
#9 x 3-1/8"	5 POUNDS (~360 COUNT)	T-25
#9 x 3-1/8"	BULK BOX (1,800 COUNT)	T-25

Discounts apply to any purchase of two + identical quantities (1 Pound, 5 Pound or Bulk) in course of same order.

- Order 2 or More 1 Pound Gold Star Wood Screws or other Screws - **Save 15%**
- Order 6 of More 1 Pound Gold Star Wood Screws or other Screws - **Save 25%**
- Order 2 or More 5 Pound Yellow Zinc Wood Screws or other Screws - **Save 10%**
- Order 6 of More 5 Pound Yellow Zinc Wood Screws or other Screws - **Save 20%**
- Order 2 or more Star/Torx Drive Wood Screws or other Bulk Screw Boxes - **Save 5%**
- Order 6 or more Star/Torx Drive Wood Screws or other Bulk Screw Boxes - **Save 10%**
- Order 24 (1/2 Pallet) or more Bulk Box Yellow Zinc Wood Screws **Save 15%**
- Order 48 (Full Pallet) or more Bulk Box Yellow Zinc Wood Screws **Save 20%**

- General Purpose Yellow Zinc Triple Coated Screws for professional operations & demanding industries
- Excellent screws for both hard and soft wood for cabinetry, furniture, roofing, framing, etc
- Manufactured from high quality heat treated steel
- Self-countersinking screw head (.38 head diameter)
- Deep, wide, sharp screw threads provide maximum holding power

- High quality screw threads cut cleanly & easily through tough materials
- Knurled screw shoulder lowers drill torque requirements
- Type 17 notched screw point for quick starts without "walking"
- Torx/Star Drive delivers twice the torque of Phillips or square drive screws
- Deep Torx/Star Drive screws reduce "Cam-out"
- Use with **T25 Driver Bit**



### YTX #9 x 2-3/4"

I really like the fact that I no longer have to use Phillips screws. To me, the torx screws are the best.

~ Niles, Online Reviewer

#### **Screw Engineering Specs:**

Average shear strength of 2771 lbs.  
& average Pull-Out strength is 902 lbs  
(3" Length) (Specs in Yellow Pine Wood)



# CONSTRUCTION WOOD & METAL SCREWS



Discounts apply to any purchase of two + identical quantities (1 Pound, 5 Pound or Bulk) in course of same order.

- Order 2 or More 1 Pound Gold Star Wood Screws or other Screws - **Save 15%**
- Order 6 or More 1 Pound Gold Star Wood Screws or other Screws - **Save 25%**
- Order 2 or More 5 Pound Yellow Zinc Wood Screws or other Screws - **Save 10%**
- Order 6 or More 5 Pound Yellow Zinc Wood Screws or other Screws - **Save 20%**
- Order 2 or more Star/Torx Drive Wood Screws or other Bulk Screw Boxes - **Save 5%**
- Order 6 or more Star/Torx Drive Wood Screws or other Bulk Screw Boxes - **Save 10%**
- Order 24 (1/2 Pallet) or more Bulk Box Yellow Zinc Wood Screws **Save 15%**
- Order 48 (Full Pallet) or more Bulk Box Yellow Zinc Wood Screws **Save 20%**

## #10 Gold Star "YTX" Heavy Duty Flat Head Wood Screws

SIZE	QUANTITY	DRIVE
#10 x 1-1/2"	1 POUND (~126 COUNT)	T-25
#10 x 1-1/2"	5 POUNDS (~630 COUNT)	T-25
#10 x 1-1/2"	BULK BOX (~3,000 COUNT)	T-25
#10 x 2"	1 POUND (~95 COUNT)	T-25
#10 x 2"	5 POUNDS (~490 COUNT)	T-25
#10 x 2"	BULK BOX (2,500 COUNT)	T-25
#10 x 2-1/2"	1 POUND (~74 COUNT)	T-25
#10 x 2-1/2"	5 POUNDS (~370 COUNT)	T-25
#10 x 2-1/2"	BULK BOX (2,000 COUNT)	T-25
#10 x 3"	1 POUND (~60 COUNT)	T-25
#10 x 3"	5 POUNDS (~300 COUNT)	T-25
#10 x 3"	BULK BOX (1,500 COUNT)	T-25
#10 x 3-1/8"	1 POUND (~58 COUNT)	T-25
#10 x 3-1/8"	5 POUNDS (~290 COUNT)	T-25
#10 x 3-1/8"	BULK BOX (1,500 COUNT)	T-25
#10 x 4"	1 POUND (~46 COUNT)	T-25
#10 x 4"	5 POUNDS (~230 COUNT)	T-25
#10 x 4"	BULK BOX (1,000 COUNT)	T-25
#10 x 5"	1 POUND (~36 COUNT)	T-25
#10 x 5"	5 POUNDS (~180 COUNT)	T-25
#10 x 5"	BULK BOX (750 COUNT)	T-25
#10 x 6"	1 POUND (~32 COUNT)	T-25
#10 x 6"	5 POUNDS (~160 COUNT)	T-25
#10 x 6"	BULK BOX (600 COUNT)	T-25

- General purpose Yellow Zinc triple coated screws, excellent general purpose wood screws
- For professional operations & demanding industries, for both hard and soft wood
- Screw is a great choice for cabinetry, furniture, roofing, framing, etc.
- Manufactured from high quality heat treated steel
- Self-countersinking screw head (.038 Head Diameter)

- Deep, wide, sharp screw threads provide maximum holding power
- High quality screw threads cut cleanly & easily through tough materials
- Knurled screw shoulder lowers drill torque requirements
- Type 17 notched wood screw point for quick starts without "walking"
- Torx/Star Drive delivers twice the torque of Phillips or square drive screws

- Deep Torx/Star Drive Screws reduce "Cam-out"

### Use with T25 Driver Bit

#### Screw Engineering Specs:

Average Shear Strength of 2399 lbs.  
& Average Pull-Out Strength is 1391 lbs  
(4" Length) (Specs in Yellow Pine Wood)

# CONSTRUCTION WOOD & METAL SCREWS

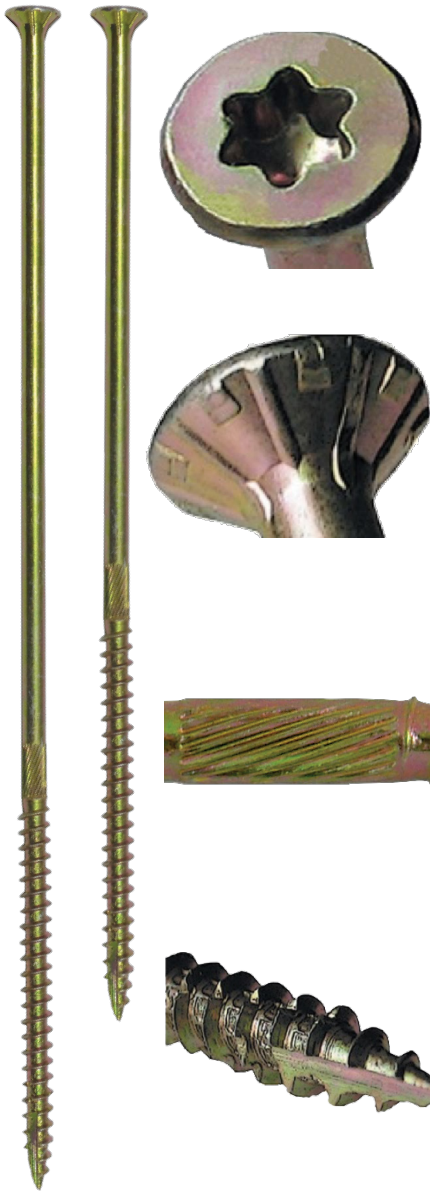

## #14 Gold Star "YTX" Heavy Duty Flat Head Wood Screws Extra Long Multi-Purpose Yellow Zinc

SIZE	QUANTITY	DRIVE
#14 x 5"	1 POUND (~30 COUNT)	T-30
#14 x 5"	5 POUNDS (~150 COUNT)	T-30
#14 x 5"	BULK BOX (500 COUNT)	T-30
#14 x 6"	1 POUND (~25 COUNT)	T-30
#14 x 6"	5 POUNDS (~125 COUNT)	T-30
#14 x 6"	BULK BOX (500 COUNT)	T-30
#14 x 7"	1 POUND (~22 COUNT)	T-30
#14 x 7"	5 POUNDS (~110 COUNT)	T-30
#14 x 7"	BULK BOX (500 COUNT)	T-30
#14 x 8"	1 POUND (~19COUNT)	T-30
#14 x 8"	5 POUNDS (~95 COUNT)	T-30
#14 x 8"	BULK BOX (500 COUNT)	T-30

Discounts apply to any purchase of two + identical quantities (1 Pound, 5 Pound or Bulk) in course of same order.

- Order 2 or More 1 Pound Extra Long Wood Screws or other Screws - **Save 15%**
- Order 6 or More 1 Pound Extra Long Wood Screws or other Screws - **Save 25%**
- Order 2 or More 5 Pound Extra Long Wood Screws or other Screws - **Save 10%**
- Order 6 of More 5 Pound Extra Long Wood Screws or other Screws - **Save 20%**
- Order 2 or more Extra Long Wood Screws or other Bulk Screw Boxes - **Save 5%**
- Order 6 or more Extra Long Wood Screws or other Bulk Screw Boxes - **Save 10%**
- Order 24 (1/2 Pallet) or more Bulk Box Yellow Zinc Wood Screws **Save 15%**
- Order 48 (Full Pallet) or more Bulk Box Yellow Zinc Wood Screws **Save 20%**

- Extra Long Wood Screws- Multipurpose Yellow Zinc Triple Coated Screws
- Excellent Multipurpose Screws
- For Professional Operations & Demanding Industries
- Excellent Screws for Both Hard and Soft Wood. Uses include: cabinetry, framing, furniture and many more
- High Quality Heat Treated Steel
- Self-Countersinking Screw Head
- Deep, Wide, Sharp Screw Threads

Provide Maximum Holding Power High Quality Screw Threads Cut Cleanly & Easily Through Tough Materials

- Our wood screws are so strong they can even be removed and reused.
- Type 17 Notched Screw Point for Quick Starts without "walking"
- Torx/Star Drive Delivers Twice the Torque of Phillips or Square Drive Screws
- Deep Torx/Star Drive Screws Reduce "Cam-out"

- Excellent Screw for Cabinetry, Furniture, Roofing, Framing, etc

### • Use T30 Torx/Star Drive Bit

#### **Screw Engineering Specs:**

Avg. Shear Strength of #8 Shank - 2527 lbs

Average Pull-Out Strength - 1403 lbs

(Screw Pull Out is Calculated with a 6" Length Screw in the wood species: Yellow Pine Wood)



# CONSTRUCTION WOOD & METAL SCREWS

## #15 Gold Star "YTX" Heavy Duty Flat Head Wood Screws - Extra Long

SIZE	QUANTITY	DRIVE
#15 x 10"	1 POUND (~12 COUNT)	T-30
#15 x 10"	5 POUNDS (~60 COUNT)	T-30
#15 x 10"	BULK BOX (250 COUNT)	T-30
#15 x 12"	1 POUND (~10 COUNT)	T-30
#15 x 12"	5 POUNDS (~50 COUNT)	T-30
#15 x 12"	BULK BOX (250 COUNT)	T-30
#15 x 14"	1 POUND (~9 COUNT)	T-30
#15 x 14"	5 POUNDS (~45 COUNT)	T-30
#15 x 14"	BULK BOX (250 COUNT)	T-30

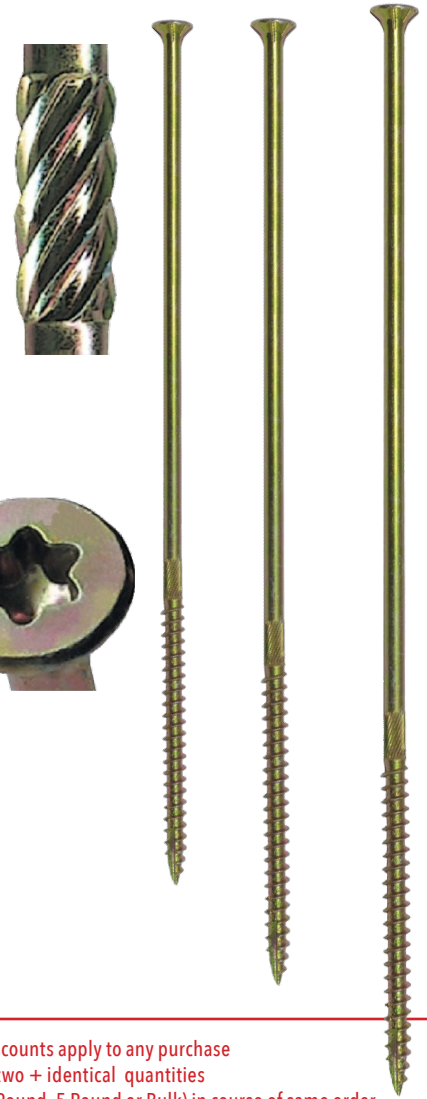

### DID YOU KNOW ... ?

At **Jake Sales** we only sell Torx head screws (also called star head and 6-lobe), with the exception of our Drywall Screws, which have a Phillips head and our Black Log Screws and Gray Structural Screws, which have a 5/16" hex head.

The reason is, a Torx head screw has the maximum amount of torque that can be applied to the screw/fastener without the risk of stripping it out. A Torx head screw/fastener can apply almost double the amount of torque compared to a Phillips head. This ensures the tightest possible joining of the two pieces of material with the maximum amount of compression.

A Torx head also allows a fastener to be screwed in using a wide variety of angles without falling off a non magnetic head, something that a Phillips head struggles with.



Discounts apply to any purchase of two + identical quantities (1 Pound, 5 Pound or Bulk) in course of same order.

- General purpose Yellow Zinc Triple Coated Screws, excellent general purpose screws
- For professional operations & demanding industries, excellent screws for both hard and soft wood
- Manufactured from high quality heat treated steel, excellent screw for cabinetry, furniture, roofing, framing, etc.
- Self-countersinking screw head
- Deep, wide, sharp screw threads provide maximum holding power
- High quality screw threads cut cleanly & easily through tough materials

- Knurled screw shoulder lowers drill torque requirements
- Type 17 Notched Screw Point for quick starts without "walking"
- Torx/Star Drive delivers twice the torque of Phillips or square drive screws
- Deep Torx/Star Drive screws reduce "Cam-out"
- Use T30 Torx/Star Drive Bit

#### Screw Engineering Specs:

Average Shear Strength of 2527 lbs.  
Average Pull-Out Strength is 1403 lbs  
(6" Length) (Specs in Yellow Pine Wood)

- Order 2 or More 1 Pound Extra Long Wood Screws or other Screws - **Save 15%**
- Order 6 or More 1 Pound Extra Long Wood Screws or other Screws - **Save 25%**
- Order 2 or More 5 Pound Extra Long Wood Screws or other Screws - **Save 10%**
- Order 6 or More 5 Pound Extra Long Wood Screws or other Screws - **Save 20%**
- Order 2 or more Extra Long Wood Screws or other Bulk Screw Boxes - **Save 5%**
- Order 6 or more Extra Long Wood Screws or other Bulk Screw Boxes - **Save 10%**
- Order 24 (1/2 Pallet) or more Bulk Box Yellow Zinc Wood Screws **Save 15%**
- Order 48 (Full Pallet) or more Bulk Box Yellow Zinc Wood Screws **Save 20%**

# CONSTRUCTION WOOD & METAL SCREWS



## #8 Bronze Star "BTX" Flat Head Exterior Wood Screws

SIZE	QUANTITY	DRIVE
#8 x 3/4"	1 POUND (~381 COUNT)	T-20
#8 x 3/4"	5 POUNDS (~1,905 COUNT)	T-20
#8 x 3/4"	BULK BOX (10,000 COUNT)	T-20
#8 x 1"	1 POUND (~288 COUNT)	T-20
#8 x 1"	5 POUNDS (~1,440 COUNT)	T-20
#8 x 1"	BULK BOX (10,000 COUNT)	T-20
#8 x 1-1/4"	1 POUND (~231 COUNT)	T-20
#8 x 1-1/4"	5 POUNDS (~1,150 COUNT)	T-20
#8 x 1-1/4"	BULK BOX (9,000 COUNT)	T-20
#8 x 1-1/2"	1 POUND (~196 COUNT)	T-20
#8 x 1-1/2"	5 POUNDS (~980 COUNT)	T-20
#8 x 1-1/2"	BULK BOX (6,500 COUNT)	T-20
#8 x 1-3/4"	1 POUND (~173 COUNT)	T-20
#8 x 1-3/4"	5 POUNDS (~865 COUNT)	T-20
#8 x 1-3/4"	BULK BOX (4,000 COUNT)	T-20
#8 x 2"	1 POUND (~151 COUNT)	T-20
#8 x 2"	5 POUNDS (~755 COUNT)	T-20
#8 x 2"	BULK BOX (3,500 COUNT)	T-20

Discounts apply to any purchase of two + identical quantities (1 Pound, 5 Pound or Bulk) in course of same order.

- Order 2 or More 1 Pound Exterior Torx Drive Wood Screws or other Screws - **Save 15%**
- Order 6 or More 1 Pound Exterior Torx Drive Wood Screws or other Screws - **Save 25%**
- Order 2 or More 5 Pound Bronze Star Wood Screws or other Screws - **Save 10%**
- Order 6 or More 5 Pound Bronze Star Wood Screws or other Screws - **Save 20%**
- Order 2 or more Torx/Star Head Wood Screws or other Bulk Screw Boxes - **Save 5%**
- Order 6 or more Torx/Star Head Wood Screws or other Bulk Screw Boxes - **Save 10%**
- Order 24 (1/2 Pallet) or more Bulk Box Yellow Zinc Wood Screws **Save 15%**
- Order 48 (Full Pallet) or more Bulk Box Yellow Zinc Wood Screws **Save 20%**



Recently tried these screws building a wood picket fence. Very impressed how easily these screws were to use. The Torx head never slipped and the screw went into the wood like a hot knife in butter. Made the job so much easier than pounding in nails. ~ Bruce, Online Reviewer

- High Performance Exterior Coated Screws, excellent general purpose screws
- For professional operations & demanding industries, excellent screws for both hard and soft wood, chipboard, and other tough materials.
- Manufactured from high quality heat treated steel with triple ceramic coating
- Corrosion resistant, salt spray tested over 1200 hours without failure
- ACQ compatible with treated lumber, outstanding abrasion resistant

- Self-countersinking screw head
- Deep, wide, sharp screw threads provide maximum holding power
- High quality screw threads cut cleanly & easily through tough materials
- Type 17 Notched Screw Point for quick starts without "walking"
- Torx/Star Drive delivers twice the torque of Phillips or square drive screws
- Deep Torx/Star Drive Screws reduce "Cam-out"

- Uses include, cabinetry, framing, furniture and many more. Our wood screws are so strong they can even be removed and reused

### • Use T20 Torx/Star Drive Bit

#### **Screw Engineering Specs:**

Average Shear Strength of #8 Shank - 2213 lbs

Average Pull-Out Strength - 363 lbs

(Screw Pull Out is Calculated with a 2" Length Screw in the wood species: Yellow Pine Wood)



# CONSTRUCTION WOOD & METAL SCREWS

## #9 Bronze Star "BTX" Flat Head Exterior Wood Screws



SIZE	QUANTITY	DRIVE
#9 x 1-1/2"	1 POUND (~140 COUNT)	T-25
#9 x 1-1/2"	5 POUNDS (~700 COUNT)	T-25
#9 x 1-1/2"	BULK BOX (3,500 COUNT)	T-25
#9 x 2"	1 POUND (~118 COUNT)	T-25
#9 x 2"	5 POUNDS (~590 COUNT)	T-25
#9 x 2"	BULK BOX (3,000 COUNT)	T-25
#9 x 2-1/2"	1 POUND (~93 COUNT)	T-25
#9 x 2-1/2"	5 POUNDS (~465 COUNT)	T-25
#9 x 2-1/2"	BULK BOX (2,500 COUNT)	T-25
#9 x 2-3/4"	1 POUND (~83 COUNT)	T-25
#9 x 2-3/4"	5 POUNDS (~415 COUNT)	T-25
#9 x 2-3/4"	BULK BOX (2,000 COUNT)	T-25
#9 x 3"	1 POUND (~79 COUNT)	T-25
#9 x 3"	5 POUNDS (~395 COUNT)	T-25
#9 x 3"	BULK BOX (2,000 COUNT)	T-25
#9 x 3-1/8"	1 POUND (~79 COUNT)	T-25
#9 x 3-1/8"	5 POUNDS (~380 COUNT)	T-25
#9 x 3-1/8"	BULK BOX (1,800 COUNT)	T-25



Discounts apply to any purchase of two + identical quantities (1 Pound, 5 Pound or Bulk) in course of same order.

- Order 2 or More 1 Pound Bronze Star Wood Screws or other Screws - **Save 15%**
- Order 6 of More 1 Pound Bronze Star Wood Screws or other Screws - **Save 25%**
- Order 2 or More 5 Pound Exterior Coated Wood Screws or other Screws - **Save 10%**
- Order 6 of More 5 Pound Exterior Coated Wood Screws or other Screws - **Save 20%**
- Order 2 or more Bronze Star Wood Screws or other Bulk Screw Boxes - **Save 5%**
- Order 6 or more Bronze Star Wood Screws or other Bulk Screw Boxes - **Save 10%**
- Order 24 (1/2 Pallet) or more Bulk Box Yellow Zinc Wood Screws **Save 15%**
- Order 48 (Full Pallet) or more Bulk Box Yellow Zinc Wood Screws **Save 20%**



- High Performance Exterior Coated Screws, excellent general purpose screws
- For professional operations & demanding industries, excellent screws for both hard and soft wood, chipboard, and other tough materials.
- Manufactured from high quality heat treated steel with triple ceramic coating
- Corrosion resistant, salt spray tested over 1200 hours without failure
- ACQ compatible with treated lumber. Outstanding abrasion resistance.
- Self-countersinking screw head (0.38 Head Diameter)
- Deep, wide, sharp screw threads provide maximum holding power
- High quality screw threads cut cleanly & easily through tough materials
- Knurled Screw Shoulder Lowers Drill Torque Requirements
- Type 17 Notched Screw Point for quick starts without "walking"
- Torx/Star Drive delivers twice the torque of Phillips or square drive screws
- Deep Torx/Star Drive Screws reduce "Cam-out"
- Excellent Screw for Fencing, Decking, Siding, Roofing, Framing, etc.
- **Use T25 Torx/Star Drive Bit**

### Screw Engineering Specs:

Average Shear Strength of 2771 lbs.  
Average Pull-Out Strength is 902 lbs (3" Length) (Specs in Yellow Pine Wood)

# CONSTRUCTION WOOD & METAL SCREWS

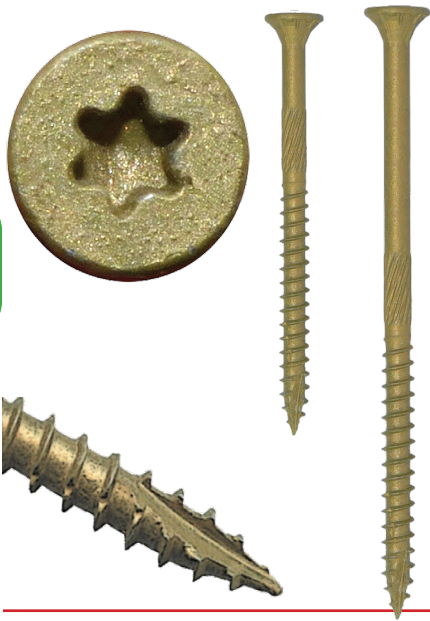

## #10 Bronze Star "BTX" Flat Head Exterior Wood Screws

SIZE	QUANTITY	DRIVE
#10 x 2"	1 POUND (~96 COUNT)	T-25
#10 x 2"	5 POUNDS (~480 COUNT)	T-25
#10 x 2"	BULK BOX (2,500 COUNT)	T-25
#10 x 2-1/2"	1 POUND (~77 COUNT)	T-25
#10 x 2-1/2"	5 POUNDS (~385 COUNT)	T-25
#10 x 2-1/2"	BULK BOX (2,000 COUNT)	T-25
#10 x 3"	1 POUND (~64 COUNT)	T-25
#10 x 3"	5 POUNDS (~320 COUNT)	T-25
#10 x 3"	BULK BOX (1,500 COUNT)	T-25
#10 x 3-1/2"	1 POUND (~54 COUNT)	T-25
#10 x 3-1/2"	5 POUNDS (~270 COUNT)	T-25
#10 x 3-1/2"	BULK BOX (1,000 COUNT)	T-25
#10 x 4"	1 POUND (~48 COUNT)	T-25
#10 x 4"	5 POUNDS (~240 COUNT)	T-25
#10 x 4"	BULK BOX (1,000 COUNT)	T-25
#10 x 5"	1 POUND (~37 COUNT)	T-25
#10 x 5"	5 POUNDS (~185 COUNT)	T-25
#10 x 5"	BULK BOX (750 COUNT)	T-25
#10 x 6"	1 POUND (~32 COUNT)	T-25
#10 x 6"	5 POUNDS (~160 COUNT)	T-25
#10 x 6"	BULK BOX (600 COUNT)	T-25

Discounts apply to any purchase of two + identical quantities (1 Pound, 5 Pound or Bulk) in course of same order.

- Order 2 or More 1 Pound HD Exterior Wood Screws or other Screws - **Save 15%**
- Order 6 of More 1 Pound HD Exterior Wood Screws or other Screws - **Save 25%**
- Order 2 or More 5 Pound Exterior Coated Wood Screws or other Screws - **Save 10%**
- Order 6 of More 5 Pound Exterior Coated Wood Screws or other Screws - **Save 20%**
- Order 2 or more Heavy Duty Wood Screws or other Bulk Screw Boxes - **Save 5%**
- Order 6 or more Heavy Duty Wood Screws or other Bulk Screw Boxes - **Save 10%**
- Order 24 (1/2 Pallet) or more Bulk Box Yellow Zinc Wood Screws **Save 15%**
- Order 48 (Full Pallet) or more Bulk Box Yellow Zinc Wood Screws **Save 20%**

- High Performance Exterior Coated Screws, excellent general purpose screws
- For professional operations & demanding industries, excellent screws for both hard and soft wood, chipboard, and other tough materials.
- Manufactured from high quality heat treated steel with triple ceramic coating
- Corrosion resistant, salt spray tested over 1200 hours without failure
- ACQ compatible with treated lumber,

- outstanding abrasion resistant
- Self-countersinking screw head (0.38 Head Diameter)
- Deep, wide, sharp screw threads provide maximum holding power
- High quality screw threads cut cleanly & easily through tough materials
- Knurled Screw Shoulder Lowers Drill Torque Requirements
- Type 17 Notched Screw Point for quick starts without "walking"
- Torx/Star Drive delivers twice the torque

- of Phillips or square drive screws
- Deep Torx/Star Drive Screws reduce "Cam-out"
- Excellent Screw for Fencing, Decking, Siding, Roofing, Framing, etc.
- **Use T25 Torx/Star Drive Bit**
- **Screw Engineering Specs:**
  - Average Shear Strength of 2399 lbs.
  - Average Pull-Out Strength is 1391 lbs
  - (4" Length) (Specs in Yellow Pine Wood)



# CONSTRUCTION WOOD & METAL SCREWS

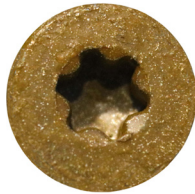

## #14 Bronze Star "BTX" Flat Head Exterior Wood Screws

SIZE	QUANTITY	DRIVE
#14 x 5"	1 POUND (~30 COUNT)	T-30
#14 x 5"	5 POUNDS (~150 COUNT)	T-30
#14 x 5"	BULK BOX (500 COUNT)	T-30
#14 x 6"	1 POUND (~25 COUNT)	T-30
#14 x 6"	5 POUNDS (~125 COUNT)	T-30
#14 x 6"	BULK BOX (500 COUNT)	T-30
#14 x 7"	1 POUND (~22 COUNT)	T-30
#14 x 7"	5 POUNDS (~110 COUNT)	T-30
#14 x 7"	BULK BOX (500 COUNT)	T-30
#14 x 8"	1 POUND (~19 COUNT)	T-30
#14 x 8"	5 POUNDS (~95 COUNT)	T-30
#14 x 8"	BULK BOX (500 COUNT)	T-30

- Extra Long Wood Screws - Triple Ceramic Coating, ACQ Treated Lumber Compatible, Abrasion Resistant
- Corrosion Resistant, Salt Spray Tested over 1200 Hours Without Coating Failure
- Manufactured from High Quality Heat Treated Steel
- With Deep, Wide, Sharp Screw Threads For Maximum Holding Power
- The Type 17 Notched Screw Point Provides Quick Starts without Screw "walking"

- Type 17 Notched Extra Sharp Wood Screw Point Reduces the Need for Pre-Drilling in Even Hard Woods
- Self-Countersinking Nibs and Drag Reducing Knurled Shoulder for a Clean and Easy Installation
- Torx/Star Drive Delivers Twice the Torque of A Phillips or Square Drive Screw Head
- Deep Torx/Star Drive Screws Reduce "Cam-out" of the Screw Head
- Use T30 Torx/Star Drive Bit

- **Screw Engineering Specs:**
- Average Shear Strength of 2399 lbs.
- Average Pull-Out Strength is 1391 lbs
- (3" Length) (Specs in Yellow Pine Wood)

Discounts apply to any purchase of two + identical quantities (1 Pound, 5 Pound or Bulk) in course of same order.

- Order 2 or More 1 Pound HD Exterior Wood Screws or other Screws - **Save 15%**
- Order 6 or More 1 Pound HD Exterior Wood Screws or other Screws - **Save 25%**
- Order 2 or More 5 Pound Exterior Coated Wood Screws or other Screws - **Save 10%**
- Order 6 or More 5 Pound Exterior Coated Wood Screws or other Screws - **Save 20%**
- Order 2 or more Heavy Duty Wood Screws or other Bulk Screw Boxes - **Save 5%**
- Order 6 or more Heavy Duty Wood Screws or other Bulk Screw Boxes - **Save 10%**
- Order 24 (1/2 Pallet) or more Bulk Box Yellow Zinc Wood Screws **Save 15%**
- Order 48 (Full Pallet) or more Bulk Box Yellow Zinc Wood Screws **Save 20%**



# HALF PALLET • PALLET & TRUCKLOAD DISCOUNTS

AVAILABLE ON SELECTED ITEMS

PLEASE CALL US  
FOR ADDITIONAL INFORMATION

406-752-5253





# CONSTRUCTION WOOD & METAL SCREWS

## #14 Construction Lag CTX Star Drive Screws

SIZE	QUANTITY	DRIVE
#14 x 1"	100 COUNT	T-25
#14 x 1"	BULK BOX (2,000 COUNT)	T-25
#14 x 1-1/2"	100 COUNT	T-25
#14 x 1-1/2"	BULK BOX (1,500 COUNT)	T-25
#14 x 2"	100 COUNT	T-25
#14 x 2"	BULK BOX (1,000 COUNT)	T-25
#14 x 2-1/2"	100 COUNT	T-25
#14 x 2-1/2"	BULK BOX (750 COUNT)	T-25
#14 x 3"	100 COUNT	T-25
#14 x 3"	BULK BOX (600 COUNT)	T-25
#14 x 4"	100 COUNT	T-25
#14 x 4"	BULK BOX (500 COUNT)	T-25
#14 x 5"	100 COUNT	T-25
#14 x 5"	BULK BOX (500 COUNT)	T-25
#14 x 6"	100 COUNT	T-25
#14 x 6"	BULK BOX (400 COUNT)	T-25

Discounts apply to any purchase of two + identical quantities (100 Count or Bulk) in course of same order.

- Order 2 or More 100 Count CTX Wood Screws **Save 10%**
- Order 6 or More 100 Count CTX Wood Screws **Save 25%**
- Order 2 or more Bulk Box CTX Wood Screws **Save 5%**
- Order 6 or more Bulk Box CTX Wood Screws **Save 10%**
- Order 24 (1/2 Pallet) or more Bulk Box CTX Wood Screws **Save 15%**
- Order 48 (Full Pallet) or more Bulk Box CTX Wood Screws **Save 20%**

- High Performance Exterior Coated Screws (1200 Hour Continuous Salt Spray Test - with NO Failures)
- Construction Lags Far Exceeds Standard Lag Bolts in Shear Force, Compression Forces and Ease of Installation
- For Professional Operations & Demanding Industries
- Excellent Screws for Both Hard and Soft Wood
- High Quality Heat Treated Steel
- 1/4" Construction Lag Screw Thread Diameter

- Modified Truss Head Screw (1/2" Head Diameter) - Resulting in Best Compression Forces
- Deep, Wide, Sharp Screw Threads Provide Maximum Holding Power
- High Quality Screw Threads Cut Cleanly & Easily Through Tough Materials
- Knurled Screw Shoulder Lowers Drill Torque Requirements
- Type 17 Notched Screw Point for Quick Starts without "walking"
- Torx/Star Drive Delivers Twice the Torque of Phillips or Square Drive Screws

- **Use with T25 Driver Bit**
- Deep Torx/Star Drive Screws Reduce "Cam-out" - Easy Installation
- Excellent Screw for Fencing, Decking, Siding, Roofing, Framing, etc

### Screw Engineering Specs:

Average Shear Strength of 2858 lbs  
Average Pull-Out Strength is 897 lbs  
(3" Length) Specs in Yellow Pine Wood



# CONSTRUCTION WOOD & METAL SCREWS



## #15 Construction Lag CTX Star Drive Screws

SIZE	QUANTITY	DRIVE
#15 x 2"	100 COUNT	T-30
#15 x 2"	BULK BOX (700 COUNT)	T-30
#15 x 2-1/2"	100 COUNT	T-30
#15 x 2-1/2"	BULK BOX (600 COUNT)	T-30
#15 x 3"	100 COUNT	T-30
#15 x 3"	BULK BOX (500 COUNT)	T-30
#15 x 3-1/2"	100 COUNT	T-30
#15 x 3-1/2"	BULK BOX (500 COUNT)	T-30
#15 x 4"	100 COUNT	T-30
#15 x 4"	BULK BOX (400 COUNT)	T-30
#15 x 5"	100 COUNT	T-30
#15 x 5"	BULK BOX (350 COUNT)	T-30
#15 x 6"	100 COUNT	T-30
#15 x 6"	BULK BOX (300 COUNT)	T-30

Discounts apply to any purchase of two + identical quantities (100 Count or Bulk) in course of same order.

- Order 2 or More 100 Count CTX Wood Screws **Save 10%**
- Order 6 or More 100 Count CTX Wood Screws **Save 25%**
- Order 2 or more Bulk Box CTX Wood Screws **Save 5%**
- Order 6 or more Bulk Box CTX Wood Screws **Save 10%**
- Order 24 (1/2 Pallet) or more Bulk Box CTX Wood Screws **Save 15%**
- Order 48 (Full Pallet) or more Bulk Box CTX Wood Screws **Save 20%**



### Fast service, great product

I needed some large quantities of screws and this was one of the best prices on the internet, way less expensive than the local home stores. Quick delivery and an excellent quality screw.~ Bruce, (Bowie, MD) Online Reviewer

- High Performance Exterior Coated Screws (Over 1200 Hour Salt Spray Test - NO Failures)
- Construction Lags Far Exceeds Standard Lag Bolts in Shear Force, Compression Forces and Ease of Installation
- For Professional Operations & Demanding Industries
- Excellent Screws for Both Hard and Soft Wood
- High Quality Heat Treated Steel
- .265" Construction Lag Screw Thread Diameter

- Modified Truss Head Screw (5/8" Head Diameter) - Resulting in Best Compression Forces
- Deep, Wide, Sharp Screw Threads Provide Maximum Holding Power
- High Quality Screw Threads Cut Cleanly & Easily Through Tough Materials
- Knurled Screw Shoulder Lowers Drill Torque Requirements
- Type 17 Notched Screw Point for Quick Starts without "walking"
- Torx/Star Drive Delivers Twice the Torque of Phillips or Square Drive Screws

- **Use with T30 Driver Bit**
- Deep Torx/Star Drive Screws Reduce "Cam-out" - Easy Installation
- Excellent Screw for Fencing, Decking, Siding, Roofing, Framing, etc.

#### Screw Engineering Specs:

Average Shear Strength of 5102 lbs.  
Average Pull-Out Strength is 1275 lbs (4" Length) (Specs in Yellow Pine Wood)



# CONSTRUCTION WOOD & METAL SCREWS

## #17 Construction Lag CTX Star Drive Screws

SIZE	QUANTITY	DRIVE
#17 x 4"	100 COUNT	T-40
#17 x 4"	BULK BOX (350 COUNT)	T-40
#17 x 5"	100 COUNT	T-40
#17 x 5"	BULK BOX (300 COUNT)	T-40
#17 x 6"	100 COUNT	T-40
#17 x 6"	BULK BOX (250 COUNT)	T-40
#17 x 7"	100 COUNT	T-40
#17 x 7"	BULK BOX (250 COUNT)	T-40
#17 x 8"	100 COUNT	T-40
#17 x 8"	BULK BOX (250 COUNT)	T-40
#17 x 10"	100 COUNT	T-40
#17 x 10"	BULK BOX (250 COUNT)	T-40
#17 x 12"	100 COUNT	T-40
#17 x 12"	BULK BOX (250 COUNT)	T-40
#17 x 14"	100 COUNT	T-40
#17 x 14"	BULK BOX (250 COUNT)	T-40
#17 x 16"	100 COUNT	T-40
#17 x 16"	BULK BOX (250 COUNT)	T-40



Discounts apply to any purchase of two + identical quantities (1 Pound, 5 Pounds or Bulk) in course of same order.

- Order 2 or More 100 Count CTX Wood Screws **Save 10%**
- Order 6 or More 100 Count CTX Wood Screws **Save 25%**
- Order 2 or more Bulk Box CTX Wood Screws **Save 5%**
- Order 6 or more Bulk Box CTX Wood Screws **Save 10%**
- Order 24 (1/2 Pallet) or more Bulk Box CTX Wood Screws **Save 15%**
- Order 48 (Full Pallet) or more Bulk Box CTX Wood Screws **Save 20%**

- High Performance Exterior Coated Screws, Salt Spray tested Over 1200 Hour Test without Failure
- Construction Lags Far Exceeds Standard Lag Bolts in Shear Force, Compression Forces and Ease of Installation
- For Professional Operations & Demanding Industries
- Excellent Screws for Both Hard and Soft Wood
- High Quality Heat Treated Steel
- .310" Construction Lag Screw Thread Diameter

- Modified Truss Head Screw (1 1/16" Head Diameter) - Resulting in Best Compression Forces
- Deep, Wide, Sharp Screw Threads Provide Maximum Holding Power
- High Quality Screw Threads Cut Cleanly & Easily Through Tough Materials
- Knurled Screw Shoulder Lowers Drill Torque Requirements
- Type 17 Notched Screw Point for Quick Starts without "walking"
- Torx/Star Drive Delivers Twice the Torque of Phillips or Square Drive Screws

- **Use with T40 Driver Bit**
- Deep Torx/Star Drive Screws Reduce "Cam-out" - Easy Installation
- Excellent Screw for Fencing, Decking, Siding, Roofing, Framing, etc.

### Screw Engineering Specs:

Average Shear Strength of 5294 lbs.

Average Pull-Out Strength is 2082 lbs (7" Length) (Specs in Yellow Pine Wood)

# CONSTRUCTION WOOD & METAL SCREWS



## #8 Silver Star Stainless Steel Flat Head "STX" Wood Screw



SIZE	QUANTITY	DRIVE
#8 x 1-1/4"	1 POUND (~230 SCREWS)	T-20
#8 x 1-1/4"	5 POUNDS (~1,150 SCREWS)	T-20
#8 x 1-1/4"	BULK BOX (9,000 COUNT)	T-20
#8 x 1-1/2"	1 POUND (~197 SCREWS)	T-20
#8 x 1-1/2"	5 POUNDS (~985 SCREWS)	T-20
#8 x 1-1/2"	BULK BOX (6,500 COUNT)	T-20
#8 x 2"	1 POUND (~153 SCREWS)	T-20
#8 x 2"	5 POUNDS (~765 SCREWS)	T-20
#8 x 2"	BULK BOX (3,500 COUNT)	T-20

Discounts apply to any purchase of two + identical quantities (1 Pound, 5 Pounds or Bulk) in course of same order.

- Order 2 or More **1 Pound** Stainless Steel Wood Screws or other Screws - **Save 15%**
- Order 6 of More **1 Pound** Stainless Steel Wood Screws or other Screws - **Save 25%**
- Order 2 or More **5 Pound** Stainless Steel Wood Screws or other Screws - **Save 10%**

- Order 6 of More **5 Pound** Stainless Steel Wood Screws or other Screws - **Save 20%**
- Order 2 or More Stainless Wood Screws or other Stainless **Bulk** Screw Boxes - **Save 5%**
- Order 6 or More Stainless Wood Screws or other Stainless Bulk Screw Boxes - **Save 10%**

**High Quality Silver Star Stainless Steel Wood Screws** come in stainless steel for maximum corrosion resistance and are the best fastener for use on exteriors where there is concern about discoloration "leaching" out around the screw head as it is exposed to the elements.

This screw also comes with the Type 17 point to reduce the risk of splintering around the insertion point.

- The Ultimate Screw for Corrosion Protection, ACQ Treated Lumber Compatible Screw
- High Quality Heat Treated Stainless Steel (305 Grade) For Professional Operations & Demanding Industries
- High Quality Heat Treated Steel, Self-Countersinking Screw Head
- Deep, Wide, Sharp Screw Threads Provide Maximum Holding Power
- High Quality Screw Threads Cut Cleanly & Easily Through Tough Materials

- Type 17 Notched Screw Point for Quick Starts without "Walking"
- Torx/Star Drive Delivers Twice the Torque of Phillips or Square Drive Screws
- Deep Torx/Star Drive Screws Reduce "Cam-out"
- Excellent Screw for applications including chemically treated materials, coastal areas, harsh weather areas, high moisture areas, and many more applications.

- **Use T20 Torx/Star Drive Bit**

### **Screw Engineering Specs:**

Average Shear Strength of #8 Shank - 933 lbs  
 Average Pull-Out Strength - 356 lbs  
 (Screw Pull Out is Calculated with a 2" Length Screw in the wood species: Yellow Pine Wood)

# CONSTRUCTION WOOD & METAL SCREWS

## #9 Silver Star Stainless Steel Flat Head "STX" Wood Screw

SIZE	QUANTITY	DRIVE
#9 x 1-5/8"	1 POUND (~164 SCREWS)	T-25
#9 x 1-5/8"	5 POUNDS (~820 SCREWS)	T-25
#9 x 1-5/8"	BULK BOX (4,000 COUNT)	T-25
#9 x 2"	1 POUND (~133 SCREWS)	T-25
#9 x 2"	5 POUNDS (~665 SCREWS)	T-25
#9 x 2"	BULK BOX (3,000 COUNT)	T-25
#9 x 2-1/2"	1 POUND (~110 SCREWS)	T-25
#9 x 2-1/2"	5 POUNDS (~550 SCREWS)	T-25
#9 x 2-1/2"	BULK BOX (2,500 COUNT)	T-25
#9 x 3"	1 POUND (~84 SCREWS)	T-25
#9 x 3"	5 POUNDS (~420 SCREWS)	T-25
#9 x 3"	BULK BOX (2,000 COUNT)	T-25

Discounts apply to any purchase of two + identical quantities (1 Pound, 5 Pounds or Bulk) in course of same order.

- Order 2 or More 1 Pound Stainless Steel Wood Screws or other Screws - **Save 15%**
- Order 6 of More 5 Pound Stainless Steel Wood Screws or other Screws - **Save 20%**
- Order 2 or more Stainless Torx/Star Wood Screws or other Bulk Screw Boxes - **Save 5%**
- Order 6 or more Stainless Torx/Star Wood Screws or other Bulk Screw Boxes - **Save 10%**
- Order 6 of More 1 Pound Stainless Steel Wood Screws or other Screws - **Save 25%**
- Order 2 or More 5 Pound Stainless Steel Wood Screws or other Screws - **Save 10%**



If there is anything we can assist you with,  
please feel free to call **(406) 752-5253**  
Monday - Friday, 8am-4pm, Mountain Time

# Jake Sales

- The Ultimate Screw for Corrosion Protection, ACQ Treated Lumber Compatible Screw
- High Quality Heat Treated Stainless Steel (305 Grade) For Professional Operations & Demanding Industries
- High Quality Heat Treated Steel, Self-Countersinking Screw Head
- Deep, Wide, Sharp Screw Threads Provide Maximum Holding Power
- High Quality Screw Threads Cut Cleanly & Easily Through Tough Materials

- Type 17 Notched Screw Point for Quick Starts without "walking"
- Torx/Star Drive Delivers Twice the Torque of Phillips or Square Drive Screws
- Deep Torx/Star Drive Screws Reduce "Cam-out"
- Excellent Screw for applications including chemically treated materials, coastal areas, harsh weather areas, high moisture areas, and many more applications.
- **Use T25 Torx/Star Drive Bit**



### Screw Engineering Specs:

Average Shear Strength of #9 Shank - 1283 lbs  
Average Pull-Out Strength - 622 lbs  
(Screw Pull Out is Calculated with a 3" Length Screw in the wood species: Yellow Pine Wood)



# CONSTRUCTION WOOD & METAL SCREWS



## #9 High Quality Silver Star Stainless Steel Trim Head Screws

SIZE	QUANTITY	DRIVE
#9 x 1-5/8"	1 POUND (~174 SCREWS)	T-20
#9 x 1-5/8"	5 POUNDS (~870 SCREWS)	T-20
#9 x 1-5/8"	BULK BOX (4,000 COUNT)	T-20
#9 x 2-1/4"	1 POUND (~125 SCREWS)	T-20
#9 x 2-1/4"	5 POUNDS (~625 SCREWS)	T-20
#9 x 2-1/4"	BULK BOX (2,500 COUNT)	T-20
#9 x 2-1/2"	1 POUND (~113 SCREWS)	T-20
#9 x 2-1/2"	5 POUNDS (~565 SCREWS)	T-20
#9 x 3"	1 POUND (~93 SCREWS)	T-20
#9 x 3"	5 POUNDS (~465 SCREWS)	T-20
#9 x 3"	BULK BOX (2,000 COUNT)	T-20
#9 x 4"	1 POUND (~65 SCREWS)	T-20
#9 x 4"	5 POUNDS (~325 SCREWS)	T-20
#9 x 4"	BULK BOX (1,500 COUNT)	T-20

Discounts apply to any purchase of two + identical quantities (1 Pound, 5 Pounds or Bulk) in course of same order.

- Order 2 or More **1 Pound** Stainless Steel TRIM Head Screws or other Screws - **Save 15%**
- Order 6 of More **1 Pound** Stainless Steel TRIM Head Screws or other Screws - **Save 25%**
- Order 2 or More **5 Pounds** Stainless Steel Trim Head Wood Screws or other Screws - **Save 10%**
- Order 6 of More **5 Pounds** Stainless Steel Trim Head Wood Screws or other Screws - **Save 20%**
- Order 2 or more Stainless Trim Head Screws or other **Bulk** Screw Boxes - **Save 5%**
- Order 6 or more Stainless Trim Head Screws or other **Bulk** Screw Boxes - **Save 10%**

- The Ultimate Screw for Corrosion Protection, ACQ Treated Lumber Compatible Screw
- High Quality Heat Treated Stainless Steel (305 Grade) For Professional Operations & Demanding Industries
- High Quality Heat Treated Steel. Self-Countersinking Screw Head
- Deep, Wide, Sharp Screw Threads Provide Maximum Holding Power
- High Quality Screw Threads Cut Cleanly & Easily Through Tough Materials

- Type 17 Notched Screw Point for Quick Starts without "walking"
- Torx/Star Drive Delivers Twice the Torque of Phillips or Square Drive Screws
- Deep Torx/Star Drive Screws Reduce "Cam-out"
- Excellent Screw for applications including chemically treated materials, coastal areas, harsh weather areas, high moisture areas, and many more applications.

- **Use T20 Torx/Star Drive Bit**

### Screw Engineering Specs:

Average Shear Strength of #9 Shank - 683 lbs  
 Average Pull-Out Strength - 781 lbs  
 (Screw Pull Out is Calculated with a 2" Length Screw in the wood species: Yellow Pine Wood)

# CONSTRUCTION WOOD & METAL SCREWS

## #10 High Quality Silver Star Stainless Steel Heavy Duty Wood Screws

SIZE	QUANTITY	DRIVE
#10 x 2-1/2"	1 POUND (~86 SCREWS)	T-25
#10 x 2-1/2"	5 POUNDS (~430 SCREWS)	T-25
#10 x 2-1/2"	BULK BOX (2,000 COUNT)	T-25
#10 x 3"	1 POUND (~72SCREWS)	T-25
#10 x 3"	5 POUNDS (~360 SCREWS)	T-25
#10 x 3"	BULK BOX (1,500 COUNT)	T-25
#10 x 3-1/2"	1 POUND (~64 SCREWS)	T-25
#10 x 3-1/2"	5 POUNDS (~320 SCREWS)	T-25
#10 x 3-1/2"	BULK BOX (1,000 COUNT)	T-25
#10 x 4"	1 POUND (~50 SCREWS)	T-25
#10 x 4"	5 POUNDS (~280 SCREWS)	T-25
#10 x 4"	BULK BOX (1,000 COUNT)	T-25



Discounts apply to any purchase of two + identical quantities (1 Pound, 5 Pounds or Bulk) in course of same order.

- Order 2 or More **1 Pound** Stainless Steel Wood Screws or other Screw - **Save 15%**
- Order 6 of More **5 Pound** Stainless Heavy Duty Wood Screws or other Screws - **Save 20%**
- Order 2 or more **1 Pound** Stainless Steel Wood Screws or other Screws - **Save 25%**
- Order 2 or more HD Stainless Steel Wood Screws or other **Bulk** Screw Boxes - **Save 5%**
- Order 2 or More **5 Pound** Stainless Steel Heavy Duty Wood Screws or other Screws - **Save 10%**
- Order 6 or more HD Stainless Steel Wood Screws or other **Bulk** Screw Boxes - **Save 10%**



*My purchase was handled quickly! I like the screws I have been using and Jake Sales answered my questions and handled the cancellations (after I provided the wrong size.) Great stainless steel screws. ~ Ray, Online Reviewer*

- The Ultimate Screw for Corrosion Protection, ACQ Treated Lumber Compatible Screw
- High Quality Heat Treated Stainless Steel (305 Grade) For Professional Operations & Demanding Industries
- High Quality Heat Treated Steel. Self-Countersinking Screw Head
- Deep, Wide, Sharp Screw Threads Provide Maximum Holding Power
- High Quality Screw Threads Cut Cleanly & Easily Through Tough Materials

- Type 17 Notched Screw Point for Quick Starts without "walking"
- Torx/Star Drive Delivers Twice the Torque of Phillips or Square Drive Screws
- Deep Torx/Star Drive Screws Reduce "Cam-out"
- Excellent Screw for applications including chemically treated materials, coastal areas, harsh weather areas, high moisture areas, and many more applications.
- **Use T25 Torx/Star Drive Bit**



### • **Screw Engineering Specs:**

- Average Shear Strength of #10 Shank - 1683 lbs
- Average Pull-Out Strength - 781 lbs
- (Screw Pull Out is Calculated with a
- 2" Length Screw in the wood species: (Yellow Pine Wood)

# CONSTRUCTION WOOD & METAL SCREWS



## #15 High Quality SCTX Stainless Steel Wood Screws

SIZE	QUANTITY	DRIVE
#15 x 2-1/2"	100 COUNT	T-30
#15 x 2-1/2"	FULL BOX (600 COUNT)	T-30
#15 x 3"	100 COUNT	T-30
#15 x 3"	FULL BOX (500 COUNT)	T-30
#15 x 4"	100 COUNT	T-30
#15 x 4"	FULL BOX (400 COUNT)	T-30
#15 x 5"	100 COUNT	T-30
#15 x 5"	FULL BOX (350 COUNT)	T-30
#15 x 6"	100 COUNT	T-30
#15 x 6"	FULL BOX (300 COUNT)	T-30

Discounts apply to any purchase of two (2) + identical quantities (100 Count or Full Box) in course of the same order.

- Order 2 or More 100 Count SCTX Screws - **Save 10%**
- Order 2 or More Full Boxes of SCTX Screws - **Save 5%**
- Order 6 or More 100 Count SCTX Screws - **Save 15%**
- Order 6 or More Full Boxes of SCTX Screws - **Save 10%**

- The Ultimate Screw for Corrosion Protection. ACQ Treated Lumber Compatible Screw
- For Professional Operations & Demanding Industries. High Quality Heat Treated Steel
- Self-Countersinking Screw Head. Deep, Wide, Sharp Screw Threads Provide Maximum Holding Power

- High Quality Screw Threads Cut Cleanly & Easily Through Tough Materials
- Type 17 Notched Screw Point for Quick Starts without "walking"
- Torx/Star Drive Delivers Twice the Torque of Phillips or Square Drive Screws

- Deep Torx/Star Drive Screws Reduce "Cam-out"
- Excellent Screw for applications including chemically treated materials, coastal areas, harsh weather areas, high moisture areas, and many more applications.
- **Use the T30 Torx/Star Drive Bit** for Installing these Quality Wood Screws.

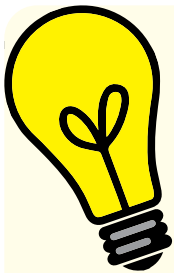

## DID YOU KNOW...?

Many construction fasteners come with a "knurl", or multiple small protrusions at the top of the threads. This helps ensure that once the end of the threads are reached, the remaining smooth surface of the fastener slides easily, allowing for higher compression forces thanks to its now greatly reduced friction.

This is an important feature to have, and many lesser quality screws/fasteners do not include this feature and it greatly assists with the quality of the installation. Screws/fasteners that are shorter and used for installations where a knurl would not be beneficial do not include it.



Additionally, if the screw was threaded all the way to the top, it would not be able to pull two pieces of timber together tightly, but would instead keep them the width of the threads apart all the way along the screw. The two pieces of timber would be fastened to the threads instead of each other, and would therefore not be tightly compressed together.

For this reason, all fasteners/screws carried by Jake Sales are not threaded all the way to the head.



# CONSTRUCTION WOOD & METAL SCREWS

## #14 x 7" Ceramic Coated Torx/Star High Performance Gutter Screws

SIZE	QUANTITY	DRIVE
#14 x 7" White	(50 COUNT)	T-30
#14 x 7" White	(250 COUNT)	T-30
#14 x 7" Brown	(50 COUNT)	T-30
#14 x 7" Brown	(250 COUNT)	T-30

- Available in Brown or White Color in Quantities of 50 or 250 per Package
- High Performance Exterior Coated Screws For Professional Operations & Demanding Industries
- Excellent Screws for Both Hard and Soft Wood
- High Quality Heat Treated Steel
- Deep, Wide, Sharp Screw Threads Provide Maximum Holding Power
- High Quality Screw Threads Cut Cleanly & Easily Through Tough Materials
- Torx/Star Drive Delivers Twice the Torque of Phillips or Square Drive Screws
- Deep Torx/Star Drive Screws Reduce "Cam-out"
- Excellent Screw for New Gutter Installation, Gutter Nail Replacement, etc.
- **Use T30 Torx/Star Drive Bit** for Installing these Quality Wood Screws



Discounts apply to any purchase of two (2) + identical quantities (100 Count or Full Box) in course of the same order.

- Order 2 or more 50 Count Gutter Screws - **Save 10%**
- Order 6 or more 50 Count Gutter Screws - **Save 15%**
- Order 2 or more 250 Count Gutter Screws - **Save 5%**
- Order 6 or more 250 Count Gutter Screws - **Save 10%**

# Jake Sales

## FURTHER INFORMATION

If there are any questions you still have regarding which screw/fastener you need to buy for your project, please reach out to us at [tom@jakesales.com](mailto:tom@jakesales.com) or call us at (406) 752-5253 during our business hours - Monday-Friday, 8am - 4pm Mountain Time

# CONSTRUCTION WOOD & METAL SCREWS

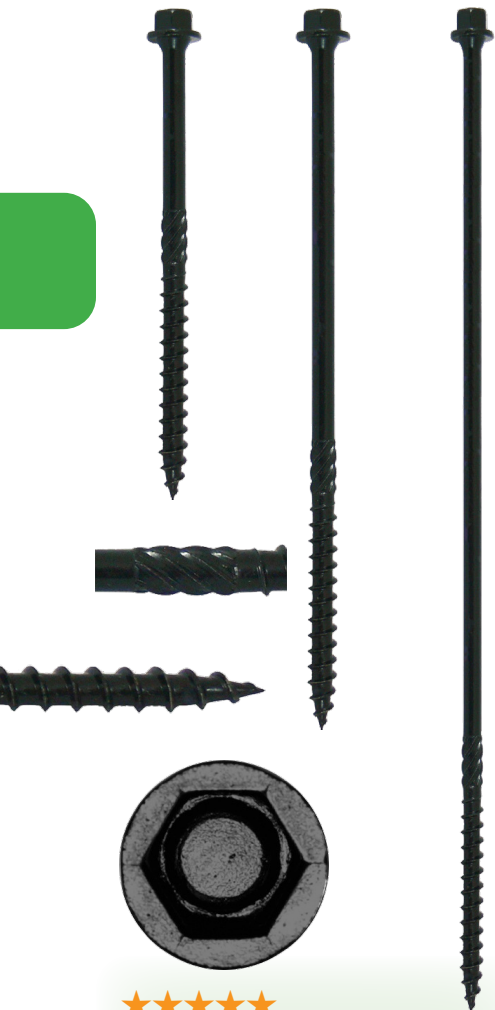

## #14 Timber Hex Black Log Wood Screws

SIZE	QUANTITY	DRIVE
#14 x 4"	(50 COUNT)	5/16" HEX
#14 x 4"	(250 COUNT)	5/16" HEX
#14 x 6"	(50 COUNT)	5/16" HEX
#14 x 6"	(250 COUNT)	5/16" HEX
#14 x 8"	(50 COUNT)	5/16" HEX
#14 x 8"	(250 COUNT)	5/16" HEX
#14 x 10"	(50 COUNT)	5/16" HEX
#14 x 10"	(250 COUNT)	5/16" HEX
#14 x 12"	(50 COUNT)	5/16" HEX
#14 x 12"	(250 COUNT)	5/16" HEX
#14 x 14"	(50 COUNT)	5/16" HEX
#14 x 14"	(250 COUNT)	5/16" HEX

Discounts apply to any purchase of two + identical quantities (50 Count or 250 Count) in course of same order.

- Order 2 or More 50 Count Black Log Timber Hex Head Screws - **Save 10%**
- Order 2 or more 250 Count Black Log Timber Hex Head Screws - **Save 5%**
- Order 6 of More 50 Count Black Log Timber Hex Head Screws - **Save 15%**
- Order 6 or more 250 Count Black Log Timber Hex Head Screws - **Save 10%**



### Order Feedback

I was very impressed with the level of customer service conducted by **Jake Sales**. The shipment was on its way to being shipped to an incorrect address (already delivered to shipping company) and yet personnel at **Jake Sales** tracked down the order and corrected the error (not their error).

This organization understands and applies customer service at a "World Class" level. I will be making more purchases from **Jake Sales**. Thank You.

~ Clyde, Online Reviewer

- Heavy Duty Wood Screws / Timber Screws / Log Screws
- Excellent Screw for Landscaping Timbers, Log Construction, etc.
- Triple Dipped Timber Screws for Superior Corrosion Resistance
- Coating was Salt Spray Tested Over 1000 Hours Without Failure
- ACQ (Treated Lumber) Compatible, For Professional Operations & Demanding Industries
- Manufactured from High Quality Heat Treated Steel
- 1/2' Washer Head (5/16" Head for More Torque & Easy Installation)
- Deep, Wide, Sharp Screw Threads Provide Maximum Holding Power
- High Quality Screw Threads Cut Cleanly & Easily Through Tough Materials
- Knurled Screw Shoulder Lowers Drill Torque Requirements
- Washer Head Provides Neat and Clean Finished Look
- **Use with 5/16" Driver Bit**

#### Screw Engineering Specs:

Average Shear Strength of - 3540 lbs.  
Average Pull-Out Strength is - 1120 lbs (6" Length) (Specs in Yellow Pine Wood)

# CONSTRUCTION WOOD & METAL SCREWS

## #17 Gray Structural Ledger Board Wood Screws

SIZE	QUANTITY	DRIVE
#17 x 4"	(50 COUNT)	5/16" HEX
#17 x 4"	(250 COUNT)	5/16" HEX
#17 x 5"	(50 COUNT)	5/16" HEX
#17 x 5"	(250 COUNT)	5/16" HEX
#17 x 6"	(50 COUNT)	5/16" HEX
#17 x 6"	(250 COUNT)	5/16" HEX
#17 x 7"	(50 COUNT)	5/16" HEX
#17 x 7"	(250 COUNT)	5/16" HEX
#17 x 9"	(50 COUNT)	5/16" HEX
#17 x 9"	(250 COUNT)	5/16" HEX

Discounts apply to any purchase of two + identical quantities (50 Count or Bulk) in course of same order

- Order 2 or more 50 Count Gray Structural Ledger Board Screws - **Save 10%**
- Order 6 or more 50 Count Gray Structural Ledger Board Screws - **Save 15%**
- Order 2 or more 250 Count Ledger Board Wood Screws - **Save 5%**
- Order 6 or more 250 Count Ledger Board Wood Screws - **Save 10%**



- Timber Screws, Ledger Board Screws, Triple Dipped Timber Screws for Superior Corrosion Resistance
- Coating Endured Over 1000 Hours of Salt Spray Testing Without Failures
- ACQ (Treated Lumber) Compatible, For Professional Operations & Demanding Industries
- Excellent Screw for Ledger Boards, Landscaping Timbers, Log Construction etc.
- Manufactured from High Quality Heat Treated Steel
- .57" (~5/8") Washer Head (5/16" Head Head for More Torque & Easy Installation)

- Deep, Wide, Sharp Screw Threads Provide Maximum Holding Power
- High Quality Screw Threads Cut Cleanly & Easily Through Tough Materials
- Knurled Screw Shoulder Lowers Drill Torque Requirements
- Washer Head Provides Neat and Clean Finished Look
- **Use with 5/16" Driver Bit**

### **Screw Engineering Specs:**

Average Shear Strength of - 1238 lbs.  
Average Pull-Out Strength is - 1360 lbs  
(6" Length) (Specs in Yellow Pine Wood)





# CONSTRUCTION WOOD & METAL SCREWS



## #9 Bronze Star Trim / Small Head Screw

SIZE	QUANTITY	DRIVE
#9 x 1-5/8"	1 POUND (~158 COUNT)	T-20
#9 x 1-5/8"	5 POUNDS (~790 COUNT)	T-20
#9 x 1-5/8"	BULK BOX (4,000 COUNT)	T-20
#9 x 2"	1 POUND (~128 COUNT)	T-20
#9 x 2"	5 POUNDS (~640 COUNT)	T-20
#9 x 2"	BULK BOX (3,000 COUNT)	T-20
#9 x 2-1/2"	1 POUND (~100 COUNT)	T-20
#9 x 2-1/2"	5 POUNDS (~500 COUNT)	T-20
#9 x 2-1/2"	BULK BOX (2,500 COUNT)	T-20
#9 x 3"	1 POUND (~84 COUNT)	T-20
#9 x 3"	5 POUNDS (~420 COUNT)	T-20
#9 x 3"	BULK BOX (2,000 COUNT)	T-20
#9 x 4"	1 POUND (~62 COUNT)	T-20
#9 x 4"	5 POUNDS (~310 COUNT)	T-20
#9 x 4"	BULK BOX (1,500 COUNT)	T-20
#9 x 5"	1 POUND (~49 COUNT)	T-20
#9 x 5"	5 POUNDS (~245 COUNT)	T-20
#9 x 5"	BULK BOX (1,000 COUNT)	T-20

Discounts apply to any purchase of two + identical quantities (1 Pound, 5 Pounds or Bulk) in course of same order.

- Order 2 or More 1 Pound Trim Head Wood Screws or other Screws **Save 15%**
- Order 6 of More 1 Pound Trim Head Wood Screws or other Screws **Save 25%**
- Order 2 or More 5 Pound Trim Head Wood Screws or other Screws **Save 10%**
- Order 6 of More 5 Pound Trim Head Wood Screws or other Screws **Save 20%**
- Order 2 or more #9 Trim Head Wood Screws or other Bulk Screw Boxes and **Save 5%**
- Order 6 or more #9 Trim Head Wood Screws or other Bulk Screw Boxes and **Save 10%**

- High Performance Exterior Coated Trim Head Screw
- For Professional Operations & Demanding Industries
- Excellent Screws for Both Hard and Soft Wood
- High Quality Heat Treated Steel Self-Countersinking Screw Head (0.24" Head Diameter)
- Deep, Wide, Sharp Screw Threads

- Provide Maximum Holding Power
- High Quality Screw Threads Cut Cleanly & Easily Through Tough Materials
- Knurled Screw Shoulder Lowers Drill Torque Requirements
- Type 17 Notched Screw Point for Quick Starts without "walking"
- Torx/Star Drive Delivers Twice the Torque of Phillips or Square Drive Screws

- **Use with T20 Driver Bit**
- Deep Torx/Star Drive Screws Reduce "Cam-out"
- Excellent Screw for Siding Trim, Corner Trim, Log Trim Accents etc.

### Screw Engineering Specs:

Average Shear Strength - 2771 lbs.  
Average Pull-Out Strength - 902 lbs  
(3" Length) (Specs in Yellow Pine Wood)

# CONSTRUCTION WOOD & METAL SCREWS

## #9 Bronze Star White Head High Performance Trim Screw

SIZE	QUANTITY	DRIVE
#9 x 1-5/8"	1 POUND (~158 COUNT)	T-20
#9 x 1-5/8"	5 POUNDS (~790 COUNT)	T-20
#9 x 1-5/8"	BULK BOX (4,000 COUNT)	T-20
#9 x 2"	1 POUND (~128 COUNT)	T-20
#9 x 2"	5 POUNDS (~640 COUNT)	T-20
#9 x 2"	BULK BOX (3,000 COUNT)	T-20
#9 x 2-1/2"	1 POUND (~100 COUNT)	T-20
#9 x 2-1/2"	5 POUNDS (~500 COUNT)	T-20
#9 x 2-1/2"	BULK BOX (2,500 COUNT)	T-20
#9 x 3"	1 POUND (~84 COUNT)	T-20
#9 x 3"	5 POUNDS (~420 COUNT)	T-20
#9 x 3"	BULK BOX (2,000 COUNT)	T-20

Discounts apply to any purchase of two + identical quantities (1 Pound, 5 Pounds or Bulk) in course of same order.

- Order 2 or More 1 Pound Trim Head Wood Screws or other Screws **Save 15%**
- Order 6 of More 1 Pound Trim Head Wood Screws or other Screws **Save 25%**
- Order 2 or More 5 Pound Trim Head Wood Screws or other Screws **Save 10%**
- Order 6 of More 5 Pound Trim Head Wood Screws or other Screws **Save 20%**
- Order 2 or more #9 Trim Head Wood Screws or other Bulk Screw Boxes and **Save 5%**
- Order 6 or more #9 Trim Head Wood Screws or other Bulk Screw Boxes and **Save 10%**

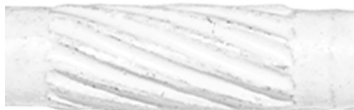

- High Performance Exterior Coated Trim Head Screw
- Excellent Multipurpose Screws For Professional Operations & Demanding Industries
- Excellent Screws for Both Hard and Soft Wood
- High Quality Heat Treated Steel with Self-Countersinking Screw Head (0.24 Screw Head Diameter)
- Deep, Wide, Sharp Screw Threads Provide Maximum Holding Power
- High Quality Screw Threads Cut Cleanly & Easily Through Tough Materials

- Type 17 Notched Screw Point for Quick Starts without "walking"
- Torx/Star Drive Delivers twice the torque of Phillips or Square Drive Screws
- Deep Torx/Star Drive Screws Reduce "Cam-out"
- Excellent Screw for Siding Trim, Corner Trim, Log Trim Accents etc.

### Screw Engineering Specs:

Average Shear Strength of #9 Shank - 2771 lbs  
Average Pull-Out Strength - 902 lbs  
(Screw Pull Out is Calculated with a 2" Length Screw in the wood species: Yellow Pine Wood)



# CONSTRUCTION WOOD & METAL SCREWS



## #15 Black Wafer Head Structural Lag Screws

SIZE	QUANTITY	DRIVE
#15 x 3"	~ 50 COUNT	T-30
#15 x 3"	FULL BOX (~500 COUNT)	T-30
#15 x 3-1/2"	~ 50 COUNT	T-30
#15 x 3-1/2"	FULL BOX (~500 COUNT)	T-30
#15 x 4"	~ 50 COUNT	T-30
#15 x 4"	FULL BOX (~400 COUNT)	T-30
#15 x 4-1/2"	~ 50 COUNT	T-30
#15 x 4-1/2"	FULL BOX (~400 COUNT)	T-30
#15 x 5"	~ 50 COUNT	T-30
#15 x 5"	FULL BOX (~350 COUNT)	T-30
#15 x 6"	~ 50 COUNT	T-30
#15 x 6"	FULL BOX (~300 COUNT)	T-30
#15 x 8"	~ 50 COUNT	T-30
#15 x 8"	FULL BOX (~250 COUNT)	T-30

Discounts apply to any purchase of two + identical quantities (1 Pound, 5 Pounds or Bulk) in course of same order.

- Order 2 or more 50 Count Black Wafer Head Structural Lag Screws Quantity - **Save 10%**
- Order 6 or more 50 Count Black Wafer Head Structural Lag Screws Quantity - **Save 15%**
- Order 2 or more Full Box Black Wafer Head Structural Lag Screws Quantity - **Save 5%**
- Order 6 or more Full Box Black Wafer Head Structural Lag Screws Quantity - **Save 10%**

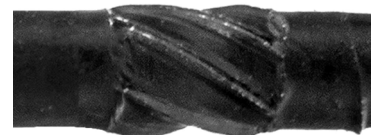

- Dimensions: Shaft diameter ~.203" - Head Diameter ~.644" - T30 Torx / Star Drive
- ACQ Compatible Coating for Outdoor or Indoor Use - 1,000 Hour Salt Spray Tested Without Failure
- Heat-treated hardened steel for high tensile strength and high shear strength
- Deep Six-Lobe Star Drive Recess reduces cam-out - Handles 2X the torque as

Phillips or Square Drive

- Type 17 Tip for Fast Starts and Eliminate Walking Without Having to Pre-Drill
- Flat Head Washer Increases Pull Through Strength and Leaves Flat Surface
- Strong Thread Reduces Chance of Incidental Screw Withdrawal or Pullout
- "V-Cut" Notches on Thread Designed

to Cut Through Material for Easy Installation at low torque speed

- These Screws can be used either for interior or exterior work. Uses include: Fencing, Log Construction, Pole Barns, Deck Posts, Ledger Board and Many Other Uses.



# CONSTRUCTION WOOD & METAL SCREWS

## #10 Star / Torx Drive Composite Deck Screw

SIZE	QUANTITY	DRIVE
#10 x 2-3/4"	1 POUND (~75 COUNT)	T-20
#10 x 2-3/4"	5 POUNDS (~350 COUNT)	T-20
#10 x 2-3/4"	BULK BOX (1,750 COUNT)	T-20

- High Quality Heat Treated Steel, Self-Countersinking Screw Head
- These screws are ACQ compatible and have a reverse thread on top of the normal thread

This ensures that the “mushroom” that can rise around a screw as it goes into wood is flattened back down for the best appearance.

- High Performance Exterior Coated Screws, C-Deck Decking Screws
- Excellent Screws for Both Hard and Soft Wood and for Composite Decking
- Deep, Wide, Sharp Screw Threads Provide Maximum Holding Power
- High Quality Screw Threads Cut Cleanly & Easily Through Tough Materials
- Sharp Screw Point for Quick Starts without “walking”

- Torx/Star Drive Delivers Twice the Torque of Phillips or Square Drive Screws

- Use in Trex Decking, Fiberon, Azek, Timber Tech and many more
- Small Self Countersinking Screws Head (0.26 Screw Head Diameter)
- Deep Torx/Star Drive Screws Reduce “Cam-out”
- **Use T20 Torx/Star Drive Bit** for Installing these Quality Wood Screw

### Screw Engineering Specs:

Average Shear Strength of #10 Shank - 1530 lbs

Average Pull-Out Strength - 356 lbs

(Screw Pull Out is Calculated with a 3" Length Screw in the wood species: Yellow Pine Wood)

Colors are Approximates (Colors vary from computer to computer)

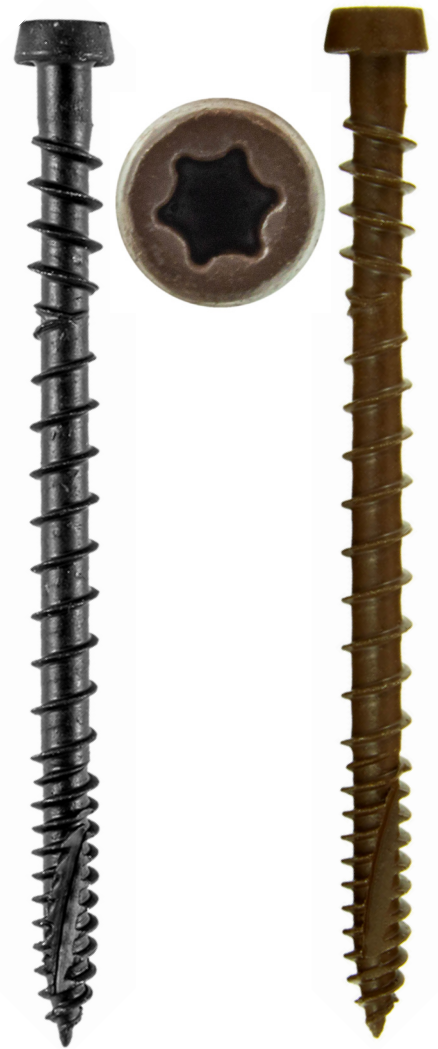

Discounts apply to any purchase of two + identical quantities (1 Pound, 5 Pounds or Bulk) in course of same order.

- Order 2 or More 1 Pound Composite Deck Screws **Save 15%**
- Order 6 or More 1 Pound Composite Deck Screws **Save 25%**
- Order 2 or More 5 Pound Composite Deck Screws **Save 10%**
- Order 6 or More 5 Pound Composite Deck Screws **Save 20%**
- Order 2 or more Bulk Box Composite Deck Screws **Save 5%**
- Order 6 or more Bulk Box Composite Deck Screws **Save 10%**
- Order 24 (1/2 Pallet) or more Bulk Box Composite Deck Screws **Save 15%**
- Order 48 (Full Pallet) or more Bulk Box Composite Deck Screws **Save 20%**



# CONSTRUCTION WOOD & METAL SCREWS



## #7 Bronze Star Modified Cabinet Truss / Washer Head Wood Screws

SIZE	QUANTITY	DRIVE
#8 x 1-1/4"	1 POUND (~217 COUNT)	T-20
#8 x 1-1/4"	5 POUNDS (~1,085 COUNT)	T-20
#8 x 1-1/4"	BULK BOX (4,000 COUNT)	T-20
#7 x 1-5/8"	1 POUND (~160 COUNT)	T-15
#7 x 1-5/8"	5 POUNDS (~800 COUNT)	T-15
#7 x 1-5/8"	BULK BOX (3,000 COUNT)	T-15
#7 x 2"	1 POUND (~138 COUNT)	T-15
#7 x 2"	5 POUNDS (~690 COUNT)	T-15
#7 x 2"	BULK BOX (2,000 COUNT)	T-15
#7 x 2-1/2"	1 POUND (~125 COUNT)	T-15
#7 x 2-1/2"	5 POUNDS (~625 COUNT)	T-15
#7 x 2-1/2"	BULK BOX (1,500 COUNT)	T-15

Discounts apply to any purchase of two + identical quantities (1 Pound, 5 Pounds or Bulk) in course of same order.

- Order 2 or More 1 Pound Modified Truss Head Wood Screws or other Screws **Save 15%**
- Order 6 of More 5 Pounds Washer Head Wood Screws or other Screws **Save 20%**
- Order 2 or more Washer Head Wood Screws or other Bulk Screw Boxes and **Save 5%**
- Order 2 or More 1 Pound Modified Truss Head Wood Screws or other Screws **Save 25%**
- Order 6 or more Washer Head Wood Screws or other Bulk Screw Boxes and **Save 10%**
- Order 2 or More 5 Pounds Washer Head Wood Screws or other Screws **Save 10%**



- High Performance Exterior Coated Screws (Excellent Performance Exterior or Interior Screw)
- Excellent General Purpose Modified Truss Head Screws
- For Professional Operations & Demanding Industries
- Excellent Screws for Both Hard and Soft Wood
- High Quality Heat Treated Steel

- Modified Truss Head Screws (0.412" Head Diameter)
- Deep, Wide, Sharp Screw Threads Provide Maximum Holding Power
- High Quality Screw Threads Cut Cleanly & Easily Through Tough Materials
- Modified Truss Head (aka Washer Head) Screws Provide the Best Compression Forces
- Type 17 Notched Screw Point for Quick Starts without "walking"

- Torx/Star Drive Delivers Twice the Torque of Phillips or Square Drive Screws
- **Use with T15 Driver Bit**
- Deep Torx/Star Drive Screws Reduce "Cam-out"
- Excellent Screw for Cabinets, Gates, Windows, Trim Fencing, Decking, Siding, Roofing, Framing, etc

# CONSTRUCTION WOOD & METAL SCREWS

## #7 Bronze Star Cabinet Modified Truss White Head (Washer Head) Wood Screws

SIZE	QUANTITY	DRIVE
#7 x 1-5/8"	1 POUND (~217 COUNT)	T-15
#7 x 1-5/8"	5 POUNDS (~1,085 COUNT)	T-15
#7 x 1-5/8"	BULK BOX (4,000 COUNT)	T-15
#7 x 2"	1 POUND (~160 COUNT)	T-15
#7 x 2"	5 POUNDS (~800 COUNT)	T-15
#7 x 2"	BULK BOX (3,000 COUNT)	T-15
#8 x 2-1/2"	1 POUND (~138 COUNT)	T-20
#8 x 2-1/2"	5 POUNDS (~690 COUNT)	T-20
#8 x 2-1/2"	BULK BOX (2,000 COUNT)	T-20



Discounts apply to any purchase of two + identical quantities (1 Pound, 5 Pounds or Bulk) in course of same order.

- Order 2 or More 1 Pound Modified Truss Head Wood Screws or other Screws **Save 15%**
- Order 6 of More 5 Pound Washer Head Wood Screws or other Screws **Save 20%**
- Order 6 of More 1 Pound Modified Truss Head Wood Screws or other Screws **Save 25%**
- Order 2 or more Washer Head Wood Screws or other Bulk Screw Boxes and **Save 5%**
- Order 2 or More 5 Pound Washer Head Wood Screws or other Screws **Save 10%**
- Order 6 or more Washer Head Wood Screws or other Bulk Screw Boxes and **Save 10%**



- High Performance Exterior Coated Screws (Excellent Performance Exterior or Interior Screw)
- Excellent General Purpose Modified Truss Head Screws For Professional Operations & Demanding Industries
- Excellent Screws for Both Hard and Soft Wood, High Quality Heat Treated Steel
- Modified Truss Head Screws (0.412" Head Diameter)
- Deep, Wide, Sharp Screw Threads

- Provide Maximum Holding Power
- High Quality Screw Threads Cut Cleanly & Easily Through Tough Materials
- Modified Truss Head (aka Washer Head) Screws Provide the Best Compression Forces
- Type 17 Notched Screw Point for Quick Starts without "walking"
- Torx/Star Drive Delivers Twice the Torque of Phillips or Square Drive Screws

- **Use with T15 Driver Bit**
- Deep Torx/Star Drive Screws Reduce "Cam-out"
- Excellent Screw for Cabinets, Gates, Windows, Trim Fencing, Decking, Siding, Roofing, Framing, etc.



# CONSTRUCTION WOOD & METAL SCREWS



## #10 Bronze Star Cabinet Modified Truss Head Screw

SIZE	QUANTITY	DRIVE
#10 x 2"	1 POUND (~83 COUNT)	T-25
#10 x 2"	5 POUNDS (~415 COUNT)	T-25
#10 x 2"	BULK BOX (2,500 COUNT)	T-25
#10 x 2-1/2"	1 POUND (~79 COUNT)	T-25
#10 x 2-1/2"	5 POUNDS (~395 COUNT)	T-25
#10 x 2-1/2"	BULK BOX (2,000 COUNT)	T-25
#10 x 3"	1 POUND (~62 COUNT)	T-25
#10 x 3"	5 POUNDS (~310 COUNT)	T-25
#10 x 3"	BULK BOX (1,500 COUNT)	T-25
#10 x 3-1/2"	1 POUND (~54 COUNT)	T-25
#10 x 3-1/2"	5 POUNDS (~270 COUNT)	T-25
#10 x 3-1/2"	BULK BOX (1,000 COUNT)	T-25

Discounts apply to any purchase of two + identical quantities (1 Pound, 5 Pounds or Bulk) in course of same order.

- Order 2 or More 1 Pound Cabinet Wood Screws or other Screws - **Save 15%**
- Order 6 of More 5 Pound Cabinet Head Wood Screws or other Screws - **Save 20%**
- Order 6 of More 1 Pound Cabinet Wood Screws or other Screws - **Save 25%**
- Order 2 or more Cabinet Head Wood Screws or other Bulk Screw Boxes and **Save 5%**
- Order 2 or More 5 Pound Cabinet Head Wood Screws or other Screws - **Save 10%**
- Order 6 or more Cabinet Head Wood Screws or other Bulk Screw Boxes and **Save 10%**

- Modified Truss (Washer Head) Head Screws Are Now Coated with a Triple Ceramic Coating for Superior Exterior Protection
- Coating Has Been Through 1200 Hours of Salt Spray Testing Without Any Coating or Screw Failures, Excellent Multipurpose Screws
- ACQ Pressure Treated Lumber Compatible, Corrosion Resistant, For Professional Operations & Demanding Industries
- Excellent Screws for Both Hard and Soft Wood
- High Quality Heat Treated Steel

- Modified Truss Washer Head Wood Screws Have the Best Compression Strengths (1/2" Head Diameter)
- Deep, Wide, Sharp Screw Threads Provide Maximum Holding Power
- High Quality Screw Threads Cut Cleanly & Easily Through Tough Materials
- Type 17 Notched Screw Point for Quick Starts without "walking"
- Torx/Star Drive Delivers Twice the Torque of Phillips or Square Drive Screws
- Deep Torx/Star Drive Screws Reduce "Cam-out"

- Excellent Screw for Cabinetry, Furniture, Roofing, Framing, etc.
- Torx/Star Drive Wood Screw Head Provides Twice the Torque of Phillips or Square Drive Screw Heads
- **Use with T25 Torx/Star Driver Bit**

### Screw Engineering Specs:

Avg. Shear Strength of #10 Shank - 2399 lbs

Average Pull-Out Strength - 1283 lbs

(Screw Pull Out is Calculated with a 3" Length Screw in the wood species: Yellow Pine Wood)

# CONSTRUCTION WOOD & METAL SCREWS

## COARSE Thread Phosphate Coated Drywall Screws

SIZE	QUANTITY	DRIVE
#6 x 1"	12.5 OZ. (~242 COUNT)	Drywall Screw Setter
#6 x 1"	5 POUNDS (~1,613 COUNT)	Drywall Screw Setter
#6 x 1"	BULK BOX (10,000 COUNT)	Drywall Screw Setter
#6 x 1-1/4"	12.5 OZ. (~207 COUNT)	Drywall Screw Setter
#6 x 1-1/4"	5 POUNDS (~1,380 COUNT)	Drywall Screw Setter
#6 x 1-1/4"	BULK BOX (8,000 COUNT)	Drywall Screw Setter
#6 x 1-5/8"	12.5 OZ. (~170 COUNT)	Drywall Screw Setter
#6 x 1-5/8"	5 POUNDS (~1,135 COUNT)	Drywall Screw Setter
#6 x 1-5/8"	BULK BOX (5,000 COUNT)	Drywall Screw Setter
#6 x 2"	12.5 OZ. (~131 COUNT)	Drywall Screw Setter
#6 x 2"	5 POUNDS (~875 COUNT)	Drywall Screw Setter
#6 x 2"	BULK BOX (3,500 COUNT)	Drywall Screw Setter
#8 x 2-1/2"	12.5 OZ. (~89 COUNT)	Drywall Screw Setter
#8 x 2-1/2"	5 POUNDS (~595 COUNT)	Drywall Screw Setter
#8 x 2-1/2"	BULK BOX (2,500 COUNT)	Drywall Screw Setter
#8 x 3"	12.5 OZ. (~71 COUNT)	Drywall Screw Setter
#8 x 3"	5 POUNDS (~475 COUNT)	Drywall Screw Setter
#8 x 3"	BULK BOX (2,000 COUNT)	Drywall Screw Setter



Discounts apply to any purchase of two + identical quantities (12.5 oz, 5 Pounds or Bulk) in course of same order.

- Order 2 or more 12.5 Ounce Gray Phosphate Drywall Screws - **Save 5%**
- Order 6 or more 12.5 Ounce Gray Phosphate Coarse Drywall Screws - **Save 10%**
- Order 2 or more Gray Phosphate Drywall Screws or other FULL BOX Screw Quantity - **Save 5%**
- Order 6 or more Gray Phosphate Drywall Screws or other FULL BOX Screw Quantity - **Save 10%**

- Excellent screw for Drywall installation
- Screws Penetrates Drywall/Sheetrock Quickly Attaching Drywall to Wall Studs
- Drywall Screws work for Many Less Demanding Applications
- Not weather proofed, not for exterior use. Suitable only for interior use
- Sheetrock/Drywall Screws are a Low Cost Alternative to other Screws for None Structural Applications
- For best results use a Phillips Head Drywall Bit Driver - sets screws evenly

**Note:** "Gray Phosphate" is more of a name than a color in the case of drywall screws. Since the original intent of drywall screws is that they function under the surface, there is no effort in manufacturing them with color consistency in mind. As a result, the color of these screws can range from gray to black.



# CONSTRUCTION WOOD & METAL SCREWS



## FINE Thread Phosphate Coated Drywall Screws

SIZE	QUANTITY	DRIVE
#6 x 1"	12.5 OZ. (~242 COUNT)	Drywall Screw Setter
#6 x 1"	5 POUNDS (~1,613 COUNT)	Drywall Screw Setter
#6 x 1"	BULK BOX (10,000 COUNT)	Drywall Screw Setter
#6 x 1-1/4"	12.5 OZ. (~207 COUNT)	Drywall Screw Setter
#6 x 1-1/4"	5 POUNDS (~1,380 COUNT)	Drywall Screw Setter
#6 x 1-1/4"	BULK BOX (8,000 COUNT)	Drywall Screw Setter
#6 x 1-5/8"	12.5 OZ. (~170 COUNT)	Drywall Screw Setter
#6 x 1-5/8"	5 POUNDS (~1,135 COUNT)	Drywall Screw Setter
#6 x 1-5/8"	BULK BOX (5,000 COUNT)	Drywall Screw Setter
#6 x 2"	12.5 OZ. (~131 COUNT)	Drywall Screw Setter
#6 x 2"	5 POUNDS (~875 COUNT)	Drywall Screw Setter
#6 x 2"	BULK BOX (3,500 COUNT)	Drywall Screw Setter
#8 x 2-1/2"	12.5 OZ. (~89 COUNT)	Drywall Screw Setter
#8 x 2-1/2"	5 POUNDS (~595 COUNT)	Drywall Screw Setter
#8 x 2-1/2"	BULK BOX (2,500 COUNT)	Drywall Screw Setter
#8 x 3"	12.5 OZ. (~71 COUNT)	Drywall Screw Setter
#8 x 3"	5 POUNDS (~475 COUNT)	Drywall Screw Setter
#8 x 3"	BULK BOX (2,000 COUNT)	Drywall Screw Setter
#10 x 4"	12.5 OZ. (~38 COUNT)	Drywall Screw Setter
#10 x 4"	5 POUNDS (~190 COUNT)	Drywall Screw Setter
#10 x 4"	BULK BOX (800 COUNT)	Drywall Screw Setter

Discounts apply to any purchase of two + identical quantities (12.5 oz, 5 Pounds or Bulk) in course of same order.

- Order 2 or more 12.5 Ounce Gray Phosphate Drywall Screws - **Save 5%**
- Order 6 or more 12.5 Ounce Gray Phosphate Coarse Drywall Screws - **Save 10%**
- Order 2 or more Gray Phosphate Drywall Screws or other FULL BOX Screw Quantity - **Save 5%**
- Order 6 or more Gray Phosphate Drywall Screws or other FULL BOX Screw Quantity - **Save 10%**

- Phosphate FINE Thread Drywall Screws designed for attaching drywall to light metal studs.
- Drywall screws can be used as all purpose screws or wood screws: good for medium duty wood screw use
- Drywall Screws AKA sheetrock screws, gypsum board, sheetrock, plasterboard & general purpose screws
- If used as an all purpose wood screw, use for interior application. Black/Gray phosphate coating.
- Sheetrock/Drywall Screws are a Low Cost Alternative to other Screws for None Structural Applications
- For best results use a Phillips Head Drywall Bit Driver - sets screws evenly

**Note:** "Gray Phosphate" is more of a name than a color in the case of drywall screws. Since the original intent of drywall screws is that they function under the surface, there is no effort in manufacturing them with color consistency in mind. As a result, the color of these screws can range from gray to black.



# CONSTRUCTION WOOD & METAL SCREWS



## COURSE Thread Yellow Zinc Coated Drywall Screws

SIZE	QUANTITY	DRIVE
#6 x 1"	12.5 OZ. (~257 COUNT)	Drywall Screw Setter
#6 x 1"	5 POUNDS (~1,660 COUNT)	Drywall Screw Setter
#6 x 1"	BULK BOX (10,000 COUNT)	Drywall Screw Setter
#6 x 1-1/4"	12.5 OZ. (~210 COUNT)	Drywall Screw Setter
#6 x 1-1/4"	5 POUNDS (~1,380 COUNT)	Drywall Screw Setter
#6 x 1-1/4"	BULK BOX (8,000 COUNT)	Drywall Screw Setter
#6 x 1-5/8"	12.5 OZ. (~171 COUNT)	Drywall Screw Setter
#6 x 1-5/8"	5 POUNDS (~1,130 COUNT)	Drywall Screw Setter
#6 x 1-5/8"	BULK BOX (5,000 COUNT)	Drywall Screw Setter
#7 x 2"	12.5 OZ. (~117 COUNT)	Drywall Screw Setter
#7 x 2"	5 POUNDS (~700 COUNT)	Drywall Screw Setter
#7 x 2"	BULK BOX (3,500 COUNT)	Drywall Screw Setter
#8 x 2-1/2"	12.5 OZ. (~85 COUNT)	Drywall Screw Setter
#8 x 2-1/2"	5 POUNDS (~594 COUNT)	Drywall Screw Setter
#8 x 2-1/2"	BULK BOX (2,500 COUNT)	Drywall Screw Setter
#8 x 3"	12.5 OZ. (~70 COUNT)	Drywall Screw Setter
#8 x 3"	5 POUNDS (~450 COUNT)	Drywall Screw Setter
#8 x 3"	BULK BOX (2,000 COUNT)	Drywall Screw Setter
#10 x 3-1/2"	12.5 OZ. (~42 COUNT)	Drywall Screw Setter
#10 x 3-1/2"	5 POUNDS (~270 COUNT)	Drywall Screw Setter
#10 x 3-1/2"	BULK BOX (1,000 COUNT)	Drywall Screw Setter
#10 x 4"	12.5 OZ. (~35 COUNT)	Drywall Screw Setter
#10 x 4"	5 POUNDS (~220 COUNT)	Drywall Screw Setter
#10 x 4"	BULK BOX (1,000 COUNT)	Drywall Screw Setter

Discounts apply to any purchase of two + identical quantities (12.5 oz, 5 Pounds or Bulk) in course of same order.

- Order 2 or more 12.5 Ounce Yellow Zinc Drywall Screws - **Save 5%**
- Order 6 or more 12.5 Ounce Yellow Zinc Drywall Screws - **Save 10%**

- Order 2 or more Yellow Zinc Drywall Screws or other FULL BOX Screw Quantity - **Save 5%**
- Order 6 or more Yellow Zinc Drywall Screws or other FULL BOX Screw Quantity - **Save 10%**

- Excellent screw for Drywall installation
- Screws Penetrates Drywall/Sheetrock Quickly Attaching Drywall to Wall Studs
- Drywall Screws work for Many Less Demanding Applications

- Sheetrock/Drywall Screws are a Low Cost Alternative to other Screws for None Structural Applications
- Purchasing These Screws in Bulk is the best value.
- For best results use a **Phillips Head Drywall Bit Driver** - sets screws evenly

# CONSTRUCTION WOOD & METAL SCREWS



## #8 Star/Torx Drive Cement Board Screws (Drill Point)

SIZE	QUANTITY	DRIVE
#8 x 1-1/4"	1 POUND (~161 COUNT)	T-25
#8 x 1-1/4"	5 POUNDS (~805 COUNT)	T-25
#8 x 1-1/4"	BULK BOX (5,000 COUNT)	T-25
#8 x 1-5/8"	1 POUND (~129 COUNT)	T-25
#8 x 1-5/8"	5 POUNDS (~645 COUNT)	T-25
#8 x 1-5/8"	BULK BOX (4,000 COUNT)	T-25

Discounts apply to any purchase of two + identical quantities (1 Pound, 5 Pounds or Bulk) in course of same order.

- Order 2 or More 1 Pound Screws for Wonderboard etc or other Screws Save 15%
- Order 6 of More 1 Pound Screws for Wonderboard etc or other Screws Save 25%
- Order 2 or More 5 Pound Drill Point Cement Board Screws or other Screws Save 10%
- Order 6 of More 5 Pound Drill Point Cement Board Screws or other Screws Save 20%
- Order 2+ Drill Point Torx Cement Board Screws or other Bulk Screw Boxes & Save 5%
- Order 6+ Drill Point Torx Cement Board Screws or other Bulk Screw Boxes & Save 10%



- Cement Board Screws: for connecting backer board/cement board/tile board to light-gauge steel
- Cement Board Screws for All Cement Board Applications, Hardiebacker, Wonderboard, PermaBase, DuRock backer board
- Star/Torx Drive Cement Board Screws are Engineered for Easy Installation in Softwood or Hardwood
- Star/Torx Drive Cement Board Screws are Ceramic Coated for Easy Installation and Corrosion Protection
- ACQ (Treated Lumber) Compatible, High Quality Heat Treated Steel Cement Board Screws
- Star/Torx Drive Cement Board Screws have a .409" Head Diameter
- T-25 Star/Torx Head for 2x the Torque of Phillips or Square Drive
- Deep, Wide, Sharp Threads Provide Maximum Holding Power (No Pre-Drilling)
- Self Countersinking Head with Cutting Nibs (Provides Neat and Clean Finished Look)
- Use with T25 Torx Driver Bit

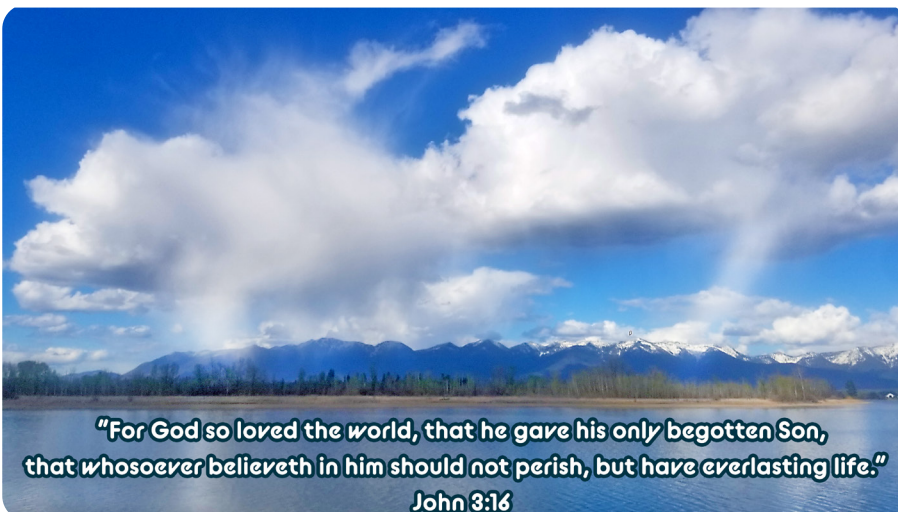

**"For God so loved the world, that he gave his only begotten Son, that whosoever believeth in him should not perish, but have everlasting life."  
John 3:16**

# CONSTRUCTION WOOD & METAL SCREWS

## #8 Star/Torx Drive Cement Board Screws (Sharp Point)

SIZE	QUANTITY	DRIVE
#8 x 1-1/4"	1 POUND (~166 COUNT)	T-25
#8 x 1-1/4"	5 POUNDS (~830 COUNT)	T-25
#8 x 1-1/4"	BULK BOX (5,000 COUNT)	T-25
#8 x 1-5/8"	1 POUND (~133 COUNT)	T-25
#8 x 1-5/8"	5 POUNDS (~665 COUNT)	T-25
#8 x 1-5/8"	BULK BOX (4,000 COUNT)	T-25

Discounts apply to any purchase of two + identical quantities (1 Pound, 5 Pounds or Bulk) in course of same order.

- Order 2 or More 1 Pound Torx Drive Cement Board Screws or other Screws Save 15%
- Order 6 of More 5 Pound Cement Board Screws or other Screws Save 20%
- Order 6 of More 1 Pound Torx Drive Cement Board Screws or other Screws Save 25%
- Order 2 or more Star/Torx Cement Board Screws or other Bulk Screw Boxes & Save 5%
- Order 2 or More 5 Pound Cement Board Screws or other Screws Save 10%
- Order 6 or more Star/Torx Cement Board Screws or other Bulk Screw Boxes & Save 10%

- Cement Board Screws for connecting backer board/cement board/tile board to wood
- Great Cement Board Screws for All Cement Board Applications, Hardiebacker, Wonderboard, PermaBase, DuRock backer board
- Star/Torx Drive Cement Board Screws are Ceramic Coated for Easy Installation and Corrosion Protection
- ACQ (Treated Lumber) Compatible, Engineered for Easy Installation in Softwood or Hardwood
- High Quality Heat Treated Steel Cement Board Screws
- Star/Torx Drive Cement Board Screws have a .409" Head Diameter
- T-25 Star/Torx Head for 2x the Torque of Phillips or Square Drive
- Deep, Wide, Sharp Threads Provide Maximum Holding Power (No Pre-Drilling)
- Self Countersinking Head with Cutting Nibs (Provides Neat and Clean Finished Look)
- **Use with T25 Torx Driver Bit**



# Jake Sales

## FURTHER INFORMATION

If there are any questions you still have regarding which screw/fastener you need to buy for your project, please reach out to us at [tom@jakesales.com](mailto:tom@jakesales.com) or call us at **(406) 752-5253** during our business hours - Monday-Friday, 8am - 4pm Mountain Time



# CONSTRUCTION WOOD & METAL SCREWS



## #7 FINE Thread Pocket Hole Cabinet Screws (Star/Torx Drive)

SIZE	QUANTITY	DRIVE
#7 x 1-1/4"	1 POUND (~186 COUNT)	T-20
#7 x 1-1/4"	5 POUNDS (~930 COUNT)	T-20
#7 x 1-1/4"	BULK BOX (6,000 COUNT)	T-20
#7 x 1-1/2"	1 POUND (~165 COUNT)	T-20
#7 x 1-1/2"	5 POUNDS (~826 COUNT)	T-20
#7 x 1-1/2"	BULK BOX (6,000 COUNT)	T-20

Discounts apply to any purchase of two + identical quantities (1 Pound, 5 Pounds or Bulk) in course of same order.

- Order 2 or More 1 Pound Pocket Hole Wood Screws or other Screws - **Save 15%**
- Order 6 of More 1 Pound Pocket Hole Wood Screws or other Screws - **Save 25%**
- Order 2 or More 5 Pound Pocket Hole Wood Screws or other Screws - **Save 10%**
- Modified Truss (Washer Head) Head Lubricated Screws, Also known as Pocket Screws or Pocket Hole Screws
- Excellent Cabinet Pocket Screws (Work Excellent with Kreg Jig®) for Cabinetry, Furniture, etc.
- For Professional Operations and Demanding Industries, Excellent Screws for Hardwood Applications (Fine Thread)
- High Quality Heat Treated Steel Pocket Hole Screws
- Modified Truss Head Cabinet Screws Have the Best Compression Strengths (.372" Head Diameter)
- Order 6 of More 5 Pound Pocket Hole Wood Screws or other Screws - **Save 20%**
- Order 2 or more Pocket Wood Screws or other Bulk Screw Boxes and - **Save 5%**
- Order 6 or more Pocket Wood Screws or other Bulk Screw Boxes and - **Save 10%**
- Deep, Wide, Sharp Screw Threads Provide Maximum Holding Power
- High Quality Screw Threads Cut Cleanly and Easily Through Tough Materials
- Type 17 Notched Screw Point for Quick Starts without "walking"
- Torx/Star Drive Delivers Twice the Torque of Phillips or Square Drive Screws
- Deep Torx/Star Drive Screws Reduce "Cam-out"
- **Use with T20 Driver Bit**



# Jake Sales

# CONSTRUCTION WOOD & METAL SCREWS

## #7 COURSE Thread Pocket Hole Cabinet Screws (Star/Torx Drive)

SIZE	QUANTITY	DRIVE
#7 x 1-1/4"	1 POUND (~199 COUNT)	T-20
#7 x 1-1/4"	5 POUNDS (~995 COUNT)	T-20
#7 x 1-1/4"	BULK BOX (5,000 COUNT)	T-20
#7 x 1-1/2"	1 POUND (~168 COUNT)	T-20
#7 x 1-1/2"	5 POUNDS (~844 COUNT)	T-20
#7 x 1-1/2"	BULK BOX (5,000 COUNT)	T-20

Discounts apply to any purchase of two + identical quantities (1 Pound, 5 Pounds or Bulk) in course of same order.

- Order 2 or More 1 Pound Pocket Hole Wood Screws or other Screws - **Save 15%**
- Order 6 of More 1 Pound Pocket Hole Wood Screws or other Screws - **Save 25%**
- Order 2 or More 5 Pound Pocket Hole Wood Screws or other Screws - **Save 10%**
- Order 6 of More 5 Pound Pocket Hole Wood Screws or other Screws - **Save 20%**
- Order 2 or more Pocket Wood Screws or other Bulk Screw Boxes and - **Save 5%**
- Order 6 or more Pocket Wood Screws or other Bulk Screw Boxes and - **Save 10%**
- Modified Truss (Washer Head) Head Lubricated Screws, Also known as Pocket Screws or Pocket Hole Screws
- Excellent Cabinet Pocket Screws (Work Excellent with Kreg Jig®) for Cabinetry, Furniture, etc.
- For Professional Operations & Demanding Industries, Great for Softwood Applications (Coarse Thread)
- Manufactured with High Quality Heat Treated Steel, Deep, Wide, Sharp Screw Threads Provide Maximum Holding Power
- Modified Truss Head Cabinet Screws Have the Best Compression Strengths (.372" Head Diameter)
- High Quality Screw Threads Cut Cleanly & Easily Through Tough Materials
- Type 17 Notched Screw Point for Quick Starts without "walking"
- Torx/Star Drive Delivers Twice the Torque of Phillips or Square Drive Screws
- Deep Torx/Star Drive Screws Reduce "Cam-out"
- **Use with T20 Driver Bit**



**Pay for Only  
What You Need  
NOT for Shipping**

**FAST & FREE SHIPPING  
TO ALL 50 US STATES**



# CONSTRUCTION WOOD & METAL SCREWS



## Blue Carbon Steel Hex Head Concrete Anchor Screws

SIZE	QUANTITY	DRIVE
3/16" x 1-1/4" Hex	100 COUNT	1/4" HEX
1/4" x 1-1/4" Hex	100 COUNT	5/16" HEX
1/4" x 1-3/4" Hex	100 COUNT	5/16" HEX
1/4" x 2-3/4" Hex	100 COUNT	5/16" HEX

- Nano Coated Concrete Anchor Screws in 3/16" and 1/4" Diameters
- 3/16" Screws for General Light to Medium Use for Interior or Exterior Applications
- 1/4" Screws Are Used for Heavier Load Applications or Where 3/16" Screws Have Difficulties Tapping Into the Material
- Both Sizes Have Blue Nano Coating For Protection Against Rusting and Corrosion of the Screws
- Concrete Anchor Screws are ACQ Treated Lumber Compatible
- Use to Attach Materials i.e. Metal or Wood Strips to Concrete, Concrete Block or Brick
- Anchor Screws Can be Removed Unlike Expansion Anchors
- Pre- Drill a Pilot Hole with a 5/32nd carbide tip drill bit for 3/16" Screws install using a **1/4" Hex Head Drive Bit**
- Pre-Drill a Pilot Hole with a 3/16" Carbide Bit for the 1/4" Screws install using a **5/16" Hex Head Drive Bit**
- The Hole Should be Drilled 1/4" - 1/2" Deeper Than the Screw Length to Allow for Dust & Debris
- Remove as Much Debris from the Hole as Possible Using Air, Vacuum or Wire Brush.
- **Do Not Over-Torque Screw to Prevent Stripping the Concrete Hole**



**40 MILLION SCREWS  
IN STOCK**

**JakeSales.com**

**(406) 752-5253**



# VINYL GATE HARDWARE / POST CAPS

## SELF CLOSING Vinyl Gate Hinges (Pair)

- Marine Powder Coated Vinyl Gate Hinges for Increased Coating Longevity
- Includes 1 Pair ((2) Vinyl Self Closing Gate Hinges)
- Includes Black / White Self Drilling 3/8" Hex Head Screws
- Gap Required Between Gate Post and Gate Frame is Between 3/4" and 1-1/2"
- Each Post Hinge Flange is 3.5" high x 3.25" wide x 1.5" deep
- Vinyl Fence Gate Hinges are Simple to Install
- Horizontally Adjustable
- Adjustable Spring Tension for More Vinyl Gate Options

### • BLACK or WHITE

Discounts Apply To Purchase of 2 Or More of this Product

- Order 2 or More Black or White Vinyl Self Closing Gate Hinges - **Save 10%**
- Order 6 or More Black or White Vinyl Self Closing Gate Hinges - **Save 20%**



## STANDARD Vinyl Gate Hinges (Pair)

- Marine Powder Coated Vinyl Gate Hinges for Increased Coating Longevity
- Includes 1 Pair ((2) Vinyl Gate Hinges)
- Includes White / Black Self Drilling 3/8" Hex Head Screws
- Gap Required Between Gate Post and Gate Frame is Between 3/4" and 1-1/2"
- Each Post Flange is 3.5" high x 3.25" wide x 1.5" deep
- Vinyl Fence Gate Hinges are Simple to Install
- Horizontally Adjustable
- Simple Installation

### • BLACK or WHITE

Discounts Apply To Purchase of 2 Or More of this Product

- Order 2 or More Black or White Vinyl Standard Gate Hinges - **Save 10%**
- Order 6 or More Black or White Vinyl Standard Gate Hinges - **Save 20%**

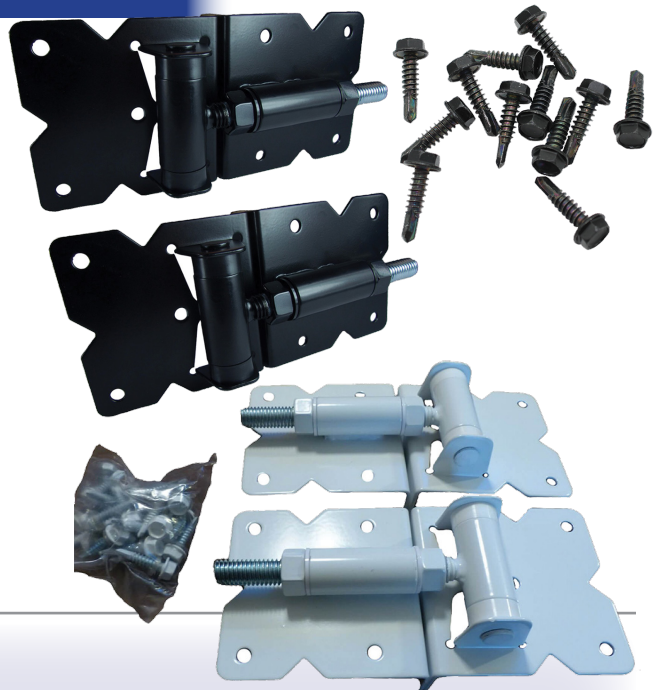

### Excellent Quality Vinyl Gate Hinges

We have used these vinyl gate hinges for many years for our fence installation business and have been very happy with the build quality and durability. The self tapping screws make installation quick and the adjustable hinge allows various distances between the gate frame and gate post making these hinges very versatile. ~ TJ (Custom Fence Inc), Online Reviewer

# VINYL GATE HARDWARE / POST CAPS

## Standard Vinyl Gate Latches

- Marine Powder Coated Vinyl Gate Latch for Increased Coating Longevity
- Includes 1 Vinyl Fence Gate Latch (Latch Keeper and Striker)
- Includes White / Black Self Drilling 3/8" Hex Head Screws
- Gap Required Between Post and Gate is Between 3/4" and 1-1/2"
- Vinyl Fence Gate Latch is Simple to Install
- Vinyl Latch Engineered for Either Right or Left Swing Gates
- Fence Gate Latch Measures 9" (W) x 5.5" (H) x 1.5" (D)
- Vinyl Gate Latch is Pad-lockable from the Side the Gate Swings

• **BLACK or WHITE**

Discounts Apply To Purchase of 2 Or More of this Product

- Order 2 or More Black or White Standard Vinyl Gate Latches - **Save 10%**
- Order 6 or More Black or White Standard Vinyl Gate Latches - **Save 20%**

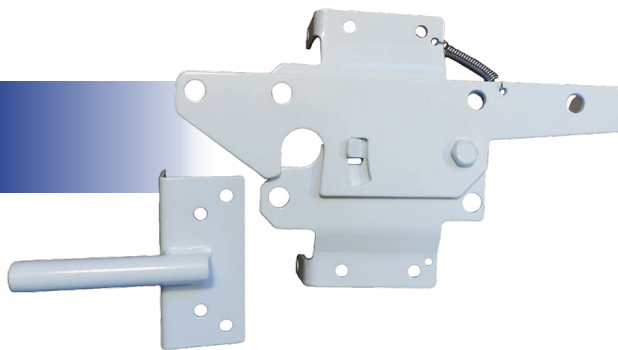

## Vinyl Gate Latch with Extension (lockable from BOTH sides)

- Vinyl Gate Latch is Pad-Lockable from Both Sides of Gate (up to 5" posts)
- Marine Powder Coated Vinyl Gate Latch for Increased Coating Longevity
- Includes 1 Vinyl Fence Gate Latch (Keeper and Striker)
- Includes Black Self Drilling 3/8" Hex Head Screws
- Gap Required Between Post and Gate is Between 3/4" and 1-1/2"
- Vinyl Fence Gate Latch is Simple to Install
- Vinyl Latch Engineered for Either Right or Left Swing Gates
- Fence Gate Latch Measures 9" (W) x 5.5" (H) x 1.5" (D)

• **BLACK or WHITE**

Discounts Apply To Purchase of 2 Or More of this Product

- Order 2 or More Black or White Vinyl Gate Latches w/Extension - **Save 10%**
- Order 6 or More Black or White Vinyl Gate Latches w/Extension - **Save 20%**

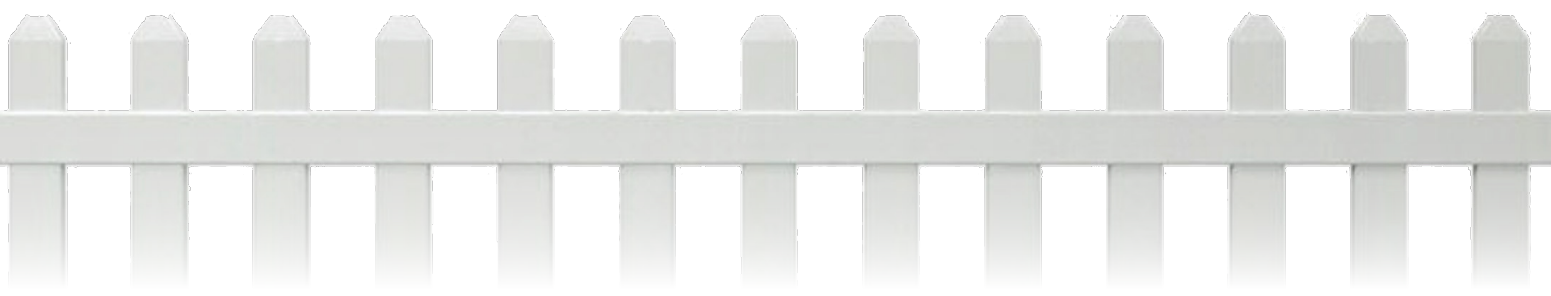
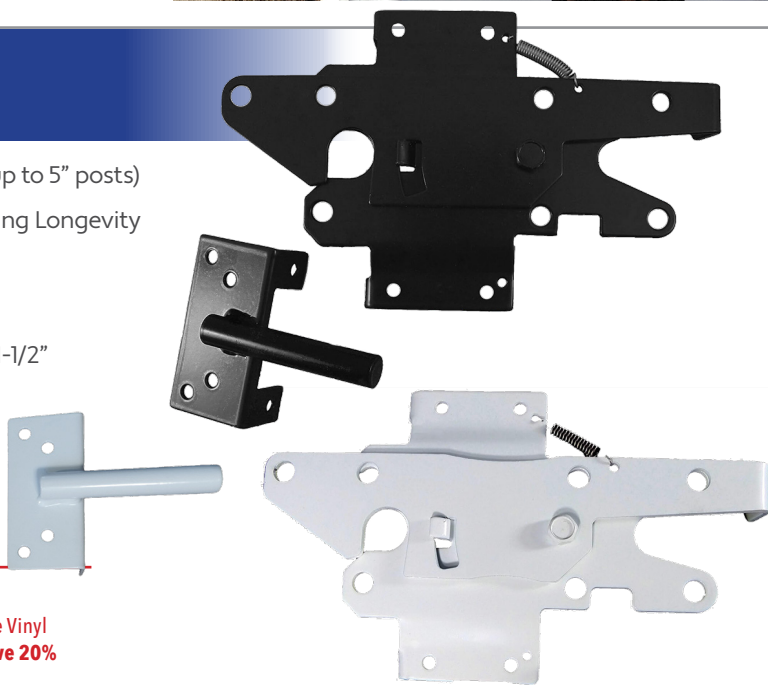

# VINYL GATE HARDWARE / POST CAPS

## SELF CLOSING Vinyl Single Gate Kit (Includes: Self-closing hinges & either side lockable latch)

- Marine Powder Coated Vinyl Gate Kit for Increased Coating Longevity
- Includes 1 Pair ((2) Vinyl Gate Hinges)
- Includes 1 Vinyl Gate Latch (Latch Striker & Latch Keeper)
- Includes Self Drilling 3/8" Hex Head Screws
- Fence Gate LATCH Measures 9" (W) x 5.5" (H) x 1.5" (D) & is Pad-lockable for Extra Gate Security.
- Latch Operates From Both Sides of Gate
- The Vinyl Gate Hinges and Latch in This Kit Are Adjustable to Fit a Gap from 3/4" to 1-1/2" Between the Gate Frame and the Gate Post.
- Spring Self Closing Mechanism GATE HINGES have Adjustable Tension for Different Gate Weights/Sizes
- These Are Easy Gate Hinges to Install and Come with Installation Instructions

### • BLACK or WHITE

Discounts Apply To Purchase of 3 Or More of this Product

- Order 3 or More Black or White Self Closing Gate Kits - **Save 10%**
- Order 10 or More Black or White Self Closing Gate Kits - **Save 20%**



## STANDARD Vinyl Single Gate Kit (Includes Hinges & Latch)

- Marine Powder Coated Vinyl Gate Kit for Increased Coating Longevity
- Includes 1 Pair ((2) Vinyl Gate Hinges)
- Includes 1 Vinyl Gate Latch (Latch Striker & Latch Keeper)
- Includes White Self Drilling 3/8" Hex Head Screws
- Gap Required Between Gate Posts and Gate Frame is Between 3/4" and 1-1/2"
- Each Post Hinge Flange is 3.5" (H) x 3.25" (W) x 1.5" (D)
- Fence Gate Latch Measures 9" (W) x 5.5" (H) x 1.5" (D)
- Vinyl Gate Hinge & Latch Kit is Engineered for Either Right or Left Swing Gates
- Vinyl Fence Gate Hinges & Latch are Simple to Install
- Horizontally Adjustable (Hinges & Latch)
- Vinyl Gate Latch is Pad-lockable from the Side the Gate Swings

### • BLACK or WHITE

Discounts Apply To Purchase of 3 Or More of this Product

- Order 3 or More Black or White Self Closing Gate Kits - **Save 10%**
- Order 10 or More Black or White Self Closing Gate Kits - **Save 20%**

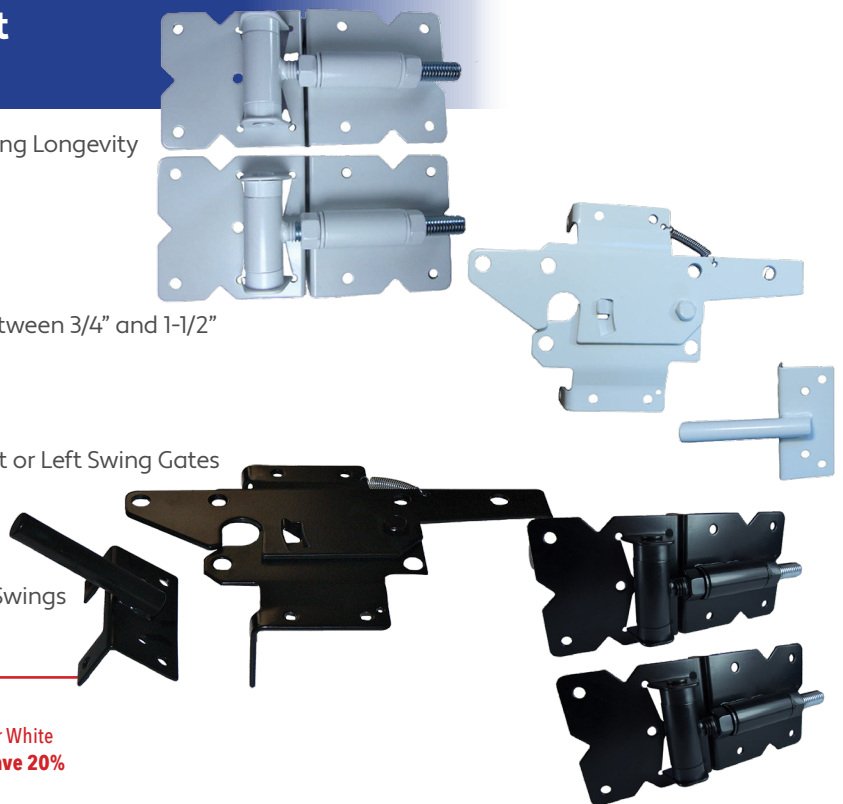



# VINYL GATE HARDWARE / POST CAPS



## SELF CLOSING Vinyl Double Gate Kit (Vinyl Gate Hinges, Latch & 24" Drop Rod)

- Marine Powder Coated Vinyl Gate Kit for Increased Coating Longevity
- Includes 2 Pair ((4) Vinyl Gate Spring Loaded Self Closing Hinges)
- Includes 1 Vinyl Gate Latch (Latch Striker & Latch Keeper)
- Includes White Self Drilling 3/8" Hex Head Screws
- Horizontally Adjustable (Hinges & Latch)
- Includes 1 Vinyl Gate Drop Rod/Pin w/Mounting Brackets & Standard Screws
- Vinyl Gate Drop Rod/Pin is 5/8" in Diameter and 24" Long
- Gap Required Between Gate Posts

and Gate Frame is Between 3/4" and 1-1/2"

- Each Post Hinge Flange is 3.5" (H) x 3.25" (W) x 1.5" (D)
- Fence Gate Latch Measures 9" (W) x 5.5" (H) x 1.5" (D)
- Vinyl Gate Hinge & Latch Kit is Engineered for Either Right or Left Swing Gates
- Vinyl Fence Gate Hinges & Latch are Simple to Install
- Adjustable Spring Tension for More Vinyl Gate Options
- Vinyl Gate Latch is Pad-lockable from the Side the Gate Swings
- **BLACK or WHITE**

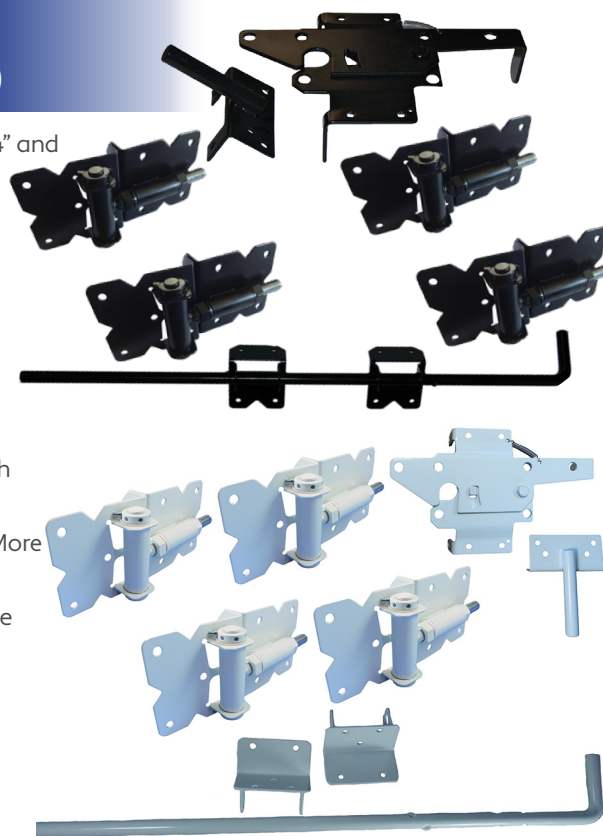

Discounts Apply To Purchase of 2 Or More of this Product

- Order 2 or More Black or White Vinyl Double Self Closing Gate Kits - **Save 10%**
- Order 6 or More Black or White Vinyl Double Self Closing Gate Kits - **Save 15%**

# VINYL GATE HARDWARE / POST CAPS

## STANDARD Vinyl Double Gate Kit (Vinyl Gate Hinges, Latch & 24" Drop Rod)

- Marine Powder Coated Vinyl Gate Kit for Increased Coating Longevity
  - Includes 2 Pair ((4) Vinyl Gate Hinges)
  - Includes 1 Vinyl Gate Latch (Latch Striker & Latch Kee
  - Includes White Self Drilling 3/8" Hex Head Screws (
  - Includes 1 Vinyl Gate Drop Rod/Pin w/Mounting Brackets & Standard Screws
  - Vinyl Gate Drop Rod/Pin is 5/8" in Diameter and 24" Long
  - Gap Required Between Gate Posts and Gate Frame is Between 3/4" and 1-1/2"
  - Each Post Hinge Flange is 3.5" (H) x 3.25" (W) x 1.5" (D)
  - Fence Gate Latch Measures 9" (W) x 5.5" (H) x 1.5" (D)
  - Vinyl Gate Hinge & Latch Kit is Engineered for Either Right or Left Swing Gates
  - Vinyl Fence Gate Hinges & Latch are Simple to Install
  - Horizontally Adjustable (Hinges & Latch)
  - Vinyl Gate Latch is Pad-lockable from the Side the Gate Swings
- **BLACK or WHITE**

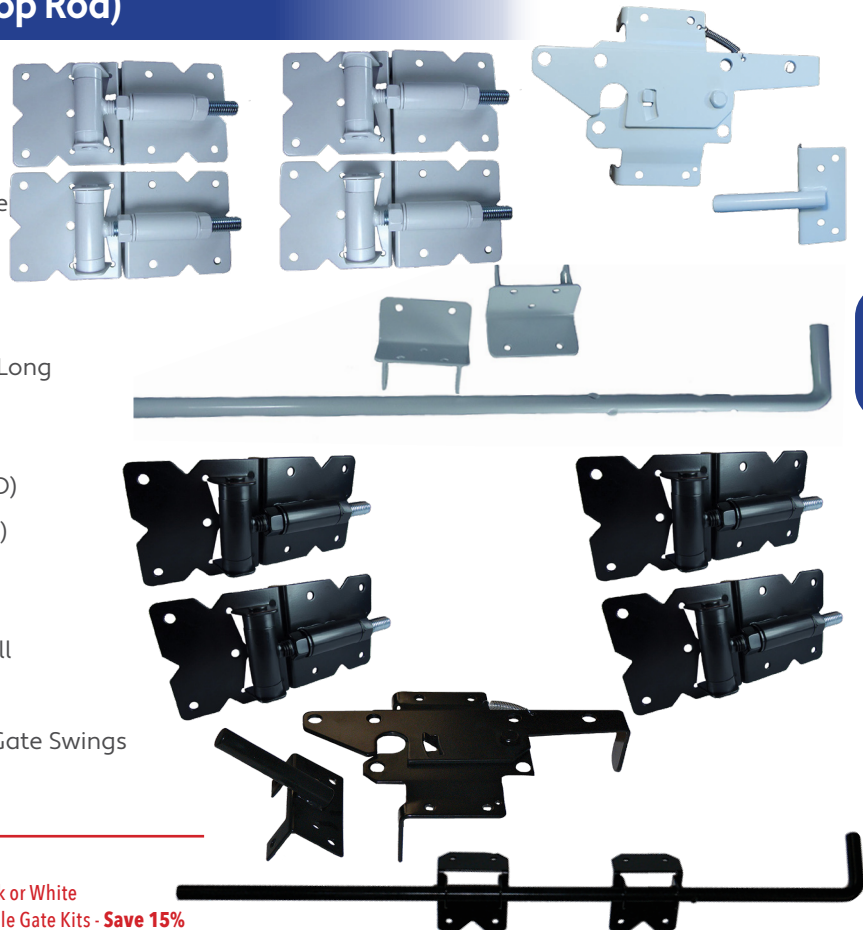

Discounts Apply To Purchase of 2 Or More of this Product

- Order 2 or More Black or White Standard Vinyl Double Gate Kits - **Save 10%**
- Order 6 or More Black or White Standard Vinyl Double Gate Kits - **Save 15%**

## Vinyl Gate Drop Rods (Black or White - 24" and 36")

- Designed for Vinyl Fence Gates, Wood Fence Gates, etc.
  - These Drop Rods Come in 24" and 36" Lengths
  - Heavy Duty 5/8" Diameter Drop Rod, Drop Pin, Cane Bolt is Strong for uses with most Double Gates
  - Powder Coated Hardware Looks Good and Increases Vinyl Gate Drop Rod Life
  - Simple to Install Gate Drop Rod With Easy to Follow Gate Drop Rod Installation Instructions.
  - Angled Brackets for Securing to Gate.
- **BLACK or WHITE**

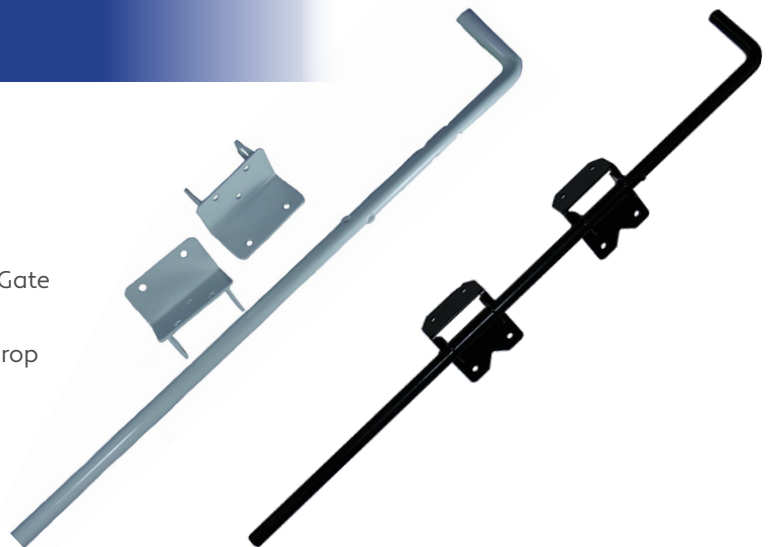

# VINYL GATE HARDWARE / POST CAPS

## Vinyl Fence Rail Mounting Bracket Wall Mount - 1-1/2" x 5-1/2"

- Vinyl Fence Bracket is also known as a Vinyl Fence Internal Fence Rail Mount. Rail Mounts Inside.
- Vinyl Fence Rail Wall Mount Bracket for mounting a 2x6 vinyl fence rail. (or a 1-1/2" x 5-1/2").
- Fasten mount to the post, wall or other vertical surface that you wish to end or start fence at
- Non fading or yellowing WHITE vinyl fence hardware.
- Bracket should last with your vinyl fence parts

Discounts Apply To Purchase of 2 Or More of this Product

- Order 2 or More Vinyl Fence Rail Mounting Brackets - **Save 35%**
- Order 10 or More Vinyl Fence Rail Mounting Brackets - **Save 50%**
- Order 100 or More Vinyl Fence Rail Mounting Brackets - **Save 80%**



## Nylon Fence Gate Handle (White or Black)

- All Purpose Gate pull for many types and styles of gates
- A versatile gate handle that is nice enough looking for vinyl gates on a large estate.
- Built strong enough for the most rugged or even rustic metal or wood gates on the farm
- The price is economical enough to use for fence gates, shed or barn doors, greenhouse doors, cellar or cabin doors
- Can be used as handles on your yard and garden box or storage box or cabinet in the shop or garage
- Constructed of Durable Nylon they will hold up in any weather

Discounts Apply To Purchase of 3 Or More of this Product

- Order 3 or More Nylon Gate Handles - **Save 25%**
- Order 10 or More Nylon Gate Handles - **Save 45%**



## HAVE QUESTIONS? NEED ANSWERS?

E-mail: [tom@jakesales.com](mailto:tom@jakesales.com)

Phone: (406) 752-5253

Website: [jakesales.com](http://jakesales.com) or [jake-sales.com](http://jake-sales.com)

# Jake Sales



# VINYL GATE HARDWARE / POST CAPS

## Ball/Dome Style Vinyl Fence Post Cap (White; 4" and 5" Styles)

- White Vinyl Fence Ball Post Cap is Made of Durable, Low-Maintenance Vinyl
- Fits Externally Over Vinyl Fence Post Keeping Water and Snow Out of Your Vinyl Fence Posts
- Inside Vinyl/PVC Post Cap Dimensions for the 4" Cap is 4.04" x 4.04" and for the 5" Cap are 5.04" x 5.04"
- Our Vinyl Fence Post Caps Fit Snugly Over Square Vinyl Posts Extending Approximately 7/8" Down Side of Post
- These White Vinyl Post Caps Contain No Resins That Will Cause Fading or Yellowing of the Product
- Post Caps Will Add a Nice Finishing Touch to Your Vinyl Fence

Discounts apply to any purchase of two (2) + of this product in course of the same order.

- Order 2 or More Vinyl Ball/Dome Post Caps and **Save 20%**
- Order 12 or More Vinyl Ball/Dome Post Caps and **Save 40%**



## Pyramid Style Vinyl Fence Post Cap (White; 4" and 5" Styles)

- These Vinyl Fence Pyramid Post Cap are Made of Durable, Low-Maintenance Vinyl
- Inside Vinyl/PVC Post Cap Dimensions are a Sharp Corner Radius.
- Our Vinyl Fence Post Caps Fit Snugly over Square Vinyl Posts Extending Approximately 7/8" Down Side of Post
- These Caps Will Fit Either a 4" x 4" or 5" x 5" Square Vinyl Fence Post
- Inside Dimension for the 4" Cap is 4.04" x 4.04" - The 5" cap has Inside Dimensions of 5.04" x 5.04"
- Our White Vinyl Post Caps contain no Resins that lend to Fading and Yellowing of the Product.
- These Post Caps Will Lend a Nice Finishing Touch to Your Vinyl Fence.

Discounts apply to any purchase of two (2) + of this product in course of the same order.

- Order 2 or More Vinyl Pyramid Post Caps and **Save 20%**
- Order 12 or More Vinyl Pyramid Post Caps and **Save 40%**



## Federation (LMT) Style Vinyl Fence Post Cap (White; 4" and 5" Styles)

- WHITE Vinyl Federation Post Cap Made of Durable, low-maintenance vinyl
- Fits Externally Over a 4" x 4" or 5" x 5" Vinyl Fence Post Keeping Water Out
- Inside Vinyl/PVC Post Cap Dimensions are 4.04" x 4.04" for the 4" Cap
- With Inside Vinyl/PVC Post Cap Dimensions of 5.04" x 5.04" for the 5" Cap
- Both Size Post Caps have a Sharp Corner Interior Radius.
- Our Vinyl Fence Post Caps Fit Snugly over 4" or 5" Vinyl Posts Extending approximately 7/8" Down Side of Post
- White Vinyl Post Caps Contain No Resins that Will Fade or Yellow
- Will Add a Nice Finishing Touch to Your Vinyl Fence

Discounts apply to any purchase of two (2) + of this product in course of the same order.

- Order 2 or More Vinyl Federation Post Caps and **Save 20%**
- Order 12 or More Vinyl Federation Post Caps and **Save 40%**

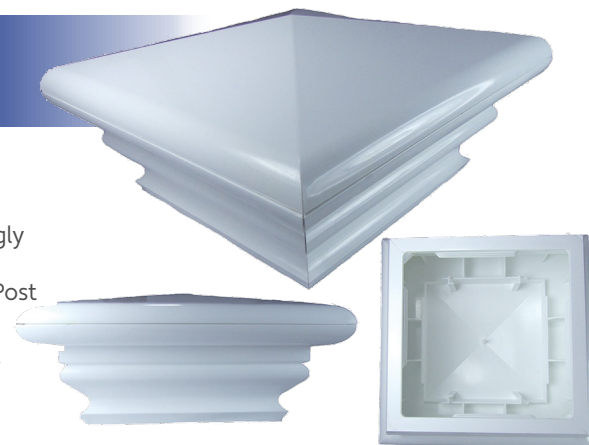

# VINYL GATE HARDWARE / POST CAPS

## New England (LMT) Style Vinyl Fence Post Cap (White; 4" and 5" Styles)



- Vinyl post cap for Vinyl fences are Made of Long Lasting, Durable, Low Maintenance Vinyl
- Caps come in two sizes 4" x 4" and 5" x 5"
- The 4" cap has inside diameter of 4.04" x 4.04" and the 5" cap is 5.04" x 5.04"
- Cap fits over the Vinyl Fence Post to Prevent Rain and Snow from Entering
- Inside the Post Cap is a Sharp, Squared Corner Radius.
- Vinyl Fence Post Caps Fit Snugly Over 4" or a 5" Vinyl Posts Extending approximately 7/8" Down Side of Post
- This Product Does Not Contain any Resins That Will Lead to Fading or Yellowing of Product
- This Cap Will Lend a Finished Look to Your Fence and Should Last for Years

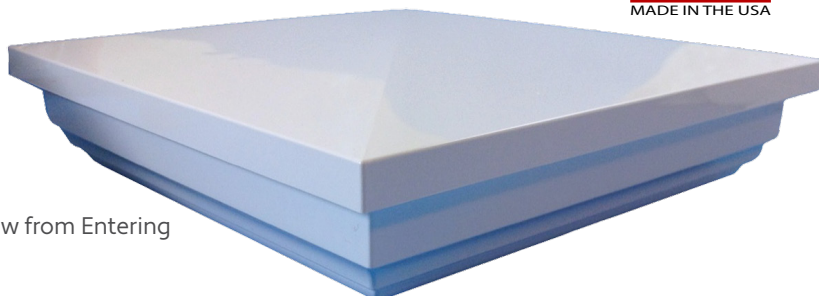

Discounts Apply To Purchase of 2 Or More of this Product

- Order 2 or More Vinyl New England Post Caps and **Save 20%**
- Order 12 or More Vinyl New England Post Caps and **Save 40%**

## Gothic Style Vinyl Fence Post Cap (White; 4" and 5" Styles)

- White Vinyl Post cap for Square PVC/Vinyl Fence Posts
- These Vinyl Fence Gothic Post Caps are Made of Durable, Low-Maintenance Vinyl
- These Caps fit Either a 4" x 4" - OR - 5" x 5" Vinyl Fence Post
- 4" Inside Dimensions are 4.04" x 4.04" - The 5" Cap has Inside Dimensions of 5.04" x 5.04"
- Both The 4" and 5" Have Inside Vinyl/PVC Post Cap Dimensions with a Sharp Turn Radius
- Vinyl Fence Post Caps Fit Snugly Over 4" or 5" Vinyl Posts, Extending Approximately 7/8" Down Side of Post
- White Vinyl Post Caps Do Not Contain any Resins that Will Lead to Fading or Yellowing of the Product
- These Caps will add a nice Finishing Touch to Your Vinyl Fence



Discounts Apply To Purchase of 2 Or More of this Product

- Order 2 or More Vinyl Gothic Post Caps and **Save 20%**
- Order 12 or More Vinyl Gothic Post Caps and **Save 40%**

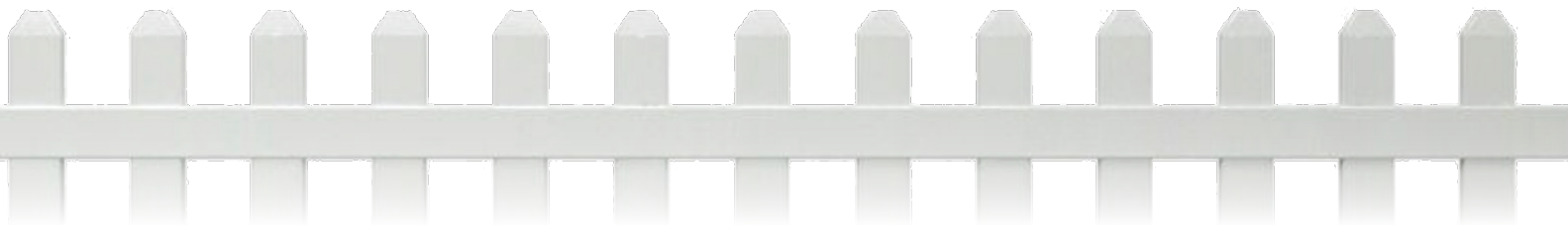

# VINYL GATE HARDWARE / POST CAPS

## Dog Eared White Vinyl Picket Fence Cap (Single Pack or 5-Pack)

- White Vinyl Fence Picket Cap Made of Durable, Low-Maintenance Vinyl.
- Easy to Install on Vinyl Fence Pickets Measuring 7/8" x 3
- Fits Internally on a 7/8" x 3" Vinyl Fence Picket Keeping Water, etc. Out of Your Vinyl Fence Pickets
- White Vinyl Post Caps Contain no Resins that will Fade or Yellow the Product
- Picket Vinyl Fence Caps Beautify the Look of Your Vinyl Picket Fence

Discounts apply to any purchase of 3+ (Qty) 5 of this product in course of the same order.

- Order 3 or More Quantity 5 Dog Eared Fence Caps and **Save 10%**



## Sharp Pointed White Vinyl Picket Fence Cap (Single Pack or 5-Pack)

- Easy to Install White Vinyl Fence Picket Cap Made of Durable, Low-Maintenance Vinyl.
- Use on 7/8" x 3" Vinyl Fence Pickets
- Fits Internally on a 7/8" x 3" Vinyl Fence Picket Keeping Water, etc. Out of Your Vinyl Fence Pickets
- White Vinyl Post Caps Contain No Resins That Will Lead to Fading or Yellowing of the Product.
- Picket Vinyl Fence Caps Beautify the Look of Your Vinyl Picket Fence

Discounts apply to any purchase of 3+ (Qty 5) of this product in course of the same order.

- Order 2 or More Vinyl Picket Pointed Fence Cap and **Save 35%**
- Order 10 or More Vinyl Picket Pointed Fence Cap and **Save 50%**

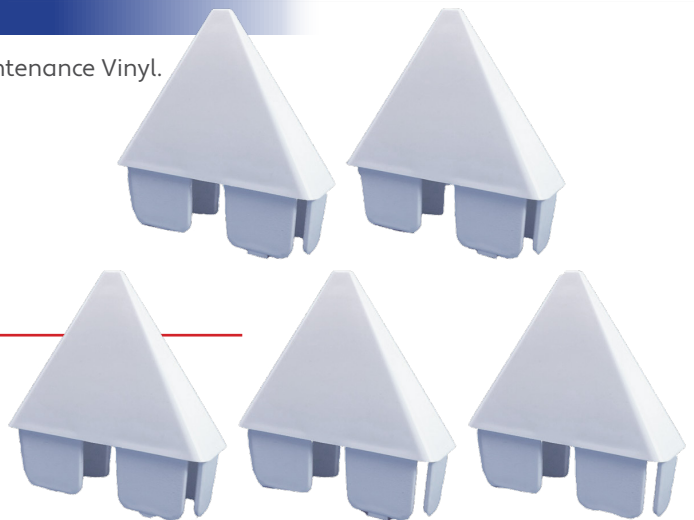

## Round Pointed White Vinyl Picket Fence Cap (Single Pack or 5-Pack)

- Easy to Install White Vinyl Fence Picket Cap Made of Durable, Low-Maintenance Vinyl.
- Fits Internally on a 7/8" x 3" Vinyl Fence Picket Keeping Water, etc. Out of Your Vinyl Fence Pickets
- Picket Vinyl Fence Caps Beautify the Look of Your Vinyl Picket Fence. Round Pointed Style Picket Cap
- White Vinyl Post Caps Do Not Contain Resins That Will Cause Fading or Yellowing of the Product.

Discounts apply to any purchase of 3+ (Qty 5) of this product in course of the same order.

- Order 2 or More Vinyl Picket Round Pointed Fence Cap and **Save 35%**
- Order 10 or More Vinyl Picket Round Pointed Fence Cap and **Save 50%**

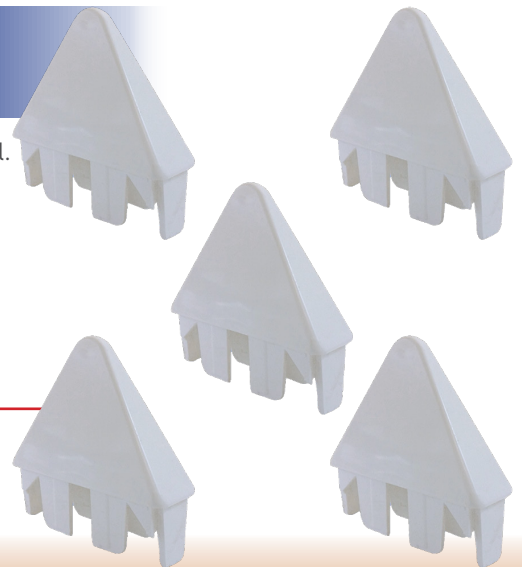



# WOOD FENCE ADAPTER & GATE HARDWARE

## Western T-Strap Hinge for Wood Gates - Qty 1 Pair

- Wood Gate T-Hinge measures 8" on long side from the center pin
- This pair of hinges measures 8" high at the highest point
- Includes gate hinge installation screws
- This hinge is easy to install
- Our wood gate hinges are powder coated BLACK for a long service life

Discounts Apply To Purchase of 2 Or More of this Product

- Order 2 or More Wood Gate Hinge Kit - **Save 10%**
- Order 6 or More Wood Gate Hinge Kit - **Save 20%**

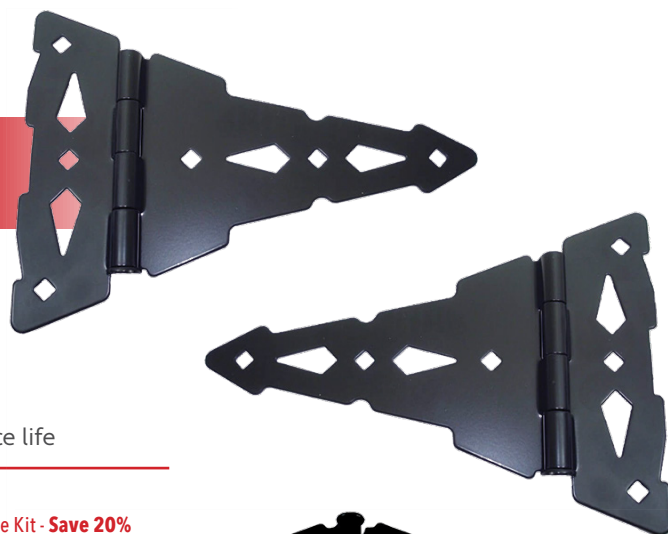

## Western Double Strap Hinge for Wood Gates - Qty 1 Pair

- Wood Gate Hinge measures 8" on each side of the center pin (16" Total Length)
- This pair of hinges measures 5" high at the highest point
- Includes gate hinge installation screws
- This hinge is easy to install
- Our wood gate hinges are powder coated BLACK for a long service life

Discounts Apply To Purchase of 2 Or More of this Product

- Order 2 or More Wood Gate Hinge Kit - **Save 10%**
- Order 6 or More Wood Gate Hinge Kit - **Save 20%**

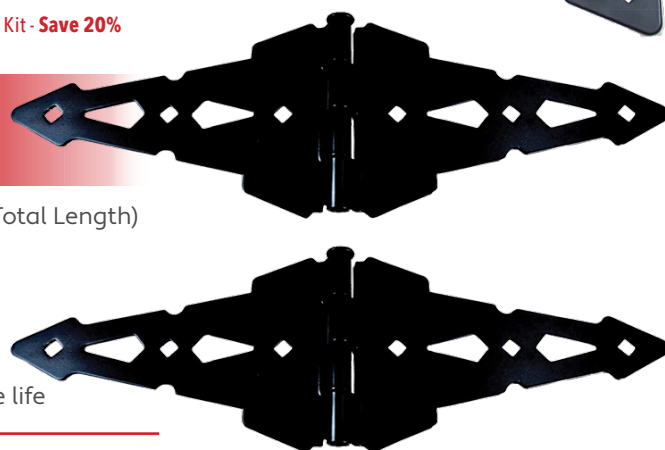

## Traditional Double Strap Hinge for Wood Gates - Qty 1 Pair

- Wood Gate Hinge measures 8" on each side of the center pin (16" Total Length)
- Hinge Measures 4-1/2" High at the Highest Point
- Includes gate hinge installation screws
- This hinge is easy to install
- Our wood gate hinges are powder coated BLACK for a long service life

Discounts Apply To Purchase of 2 Or More of this Product

- Order 2 or More Wood Gate Hinge Kit - **Save 10%**
- Order 6 or More Wood Gate Hinge Kit - **Save 20%**

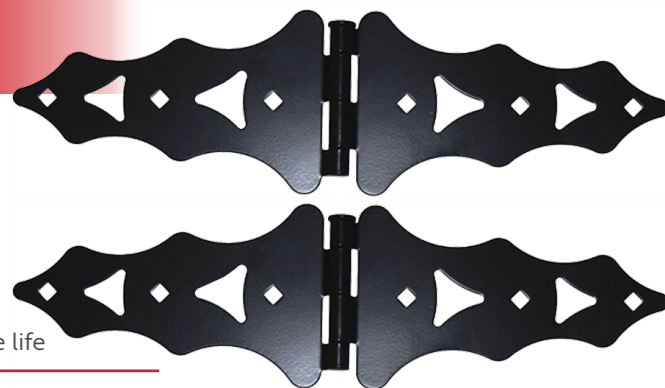

### Good Quality Wood Gate Hinges

These wood hinges are very good quality and they look good. We have installed these hinges on many wood fences for over 10 years with many happy customers to show for it. Thank you for a good quality wood gate hinge.

~ TJ, Online Reviewer

# WOOD FENCE ADAPTER & GATE HARDWARE

## Bronze Finish Double Strap Hinge for Wood Gates - Qty 1 Pair

- Wood Gate Hinge measures 8" on each side of the center pin (16" Total Length)
- This pair of hinges measures 5" high at the highest point

- Includes gate hinge installation screws
- This hinge is easy to install
- Our Wood Gate Hinges are powder coated BRONZE for a long service life

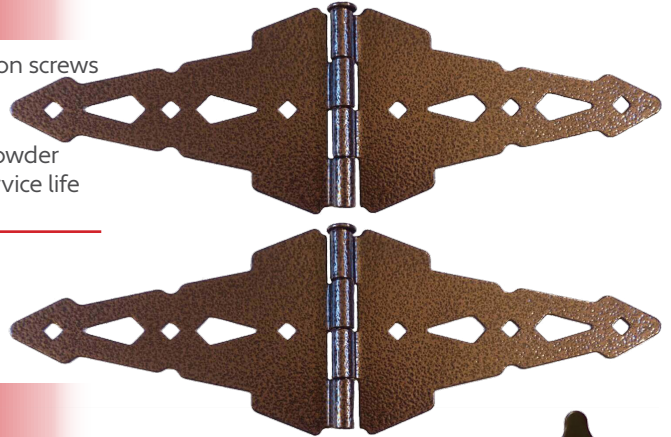

Discounts Apply To Purchase of 2 Or More of this Product

- Order 2 or More Bronze Powder Coated Wood Gate Hinges **Save 10%**
- Order 6 or More Bronze Powder Coated Wood Gate Hinges **Save 20%**

## 8" Heavy Duty Self Closing "T" Hinge for Wood Gates - Qty 1 Pair

- 8" T-Style Hinges Black Powder Coated Wood Gate Hinges
- Convenient wood fence gate hinge hardware kit for easy installation of wood fence gates
- BLACK powder coated finish on wood gate hinges for lasting durability
- Self-closing spring gate hinges have adjustable tension for

- different size fence gates
- Easy to install self-closing wood gate hinges includes lag screws
- **Size: Overall: 8" H x 9" W**
- **Gate Flange (long side) 8" x 3.25"**
- **Post Flange (vertical portion) 8" x 2"**



Discounts Apply To Purchase of 2 Or More of this Product

- Order 2 or More Wood Self Closing Gate Hinges **Save 10%**
- Order 6 or More Wood Self Closing Gate Hinges **Save 20%**

## Single Sided Wood Fence Gate Latch

- This single sided wood fence gate latch is manufactured from heavy duty zinc plated steel
- Marine grade powder coating protects against rusting and lends to long product life
- Latch can be setup with lanyard for release from opposite side of fence
- Latch can also be padlocked to provide security

- Latch bar can be mounted either left or right handed
- Easy to install with installation instructions and matching color mounting screws
- Latch bar measures 4-3/4" with total height of the latch to be 2-5/8"



Discounts Apply to the purchase of Five (5) or more of this product in the course of the same order.

- Order 5 or more Single Sided Wood Fence Gate Latch - **Save 12%**
- Order 25 or more Single Sided Wood Fence Gate Latch - **Save 25%**
- Order 16 or more Single Sided Wood Fence Gate Latch - **Save 20%**

# WOOD FENCE ADAPTER & GATE HARDWARE

## BRONZE Finish Western Style Wood Gate Latch & Handle

- Wood gate latch is powder coated hammered bronze for a long service life
- Includes matching latch mounting screws
- Latch operates from both sides of the gate
- Simple wood gate latch installation
- Gate latch is pad-lockable

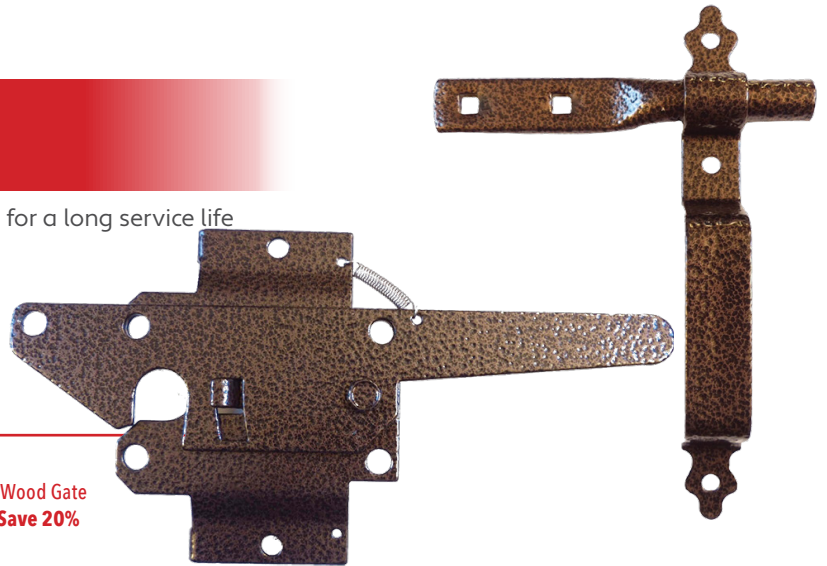

Discounts Apply To Purchase of 2 Or More of this Product

• Order 2 or More Wood Gate Latch w/Handle **Save 10%**

• Order 6 or More Wood Gate Latch w/Handle **Save 20%**

## Wood Gate Latch Kit (Latch & Handle)

- Wood fence gate latch includes 9" gate handle and mounting gate latch hardware.
- Wood gate latch opens from both sides.
- This latch is pad lockable for extra gate security
- Black powder coated finish on wood gate latch and wood gate handle
- Convenient wood fence gate hardware kit for easy installation



Discounts Apply To Purchase of 2 Or More of this Product

• Order 2 or More Wood Gate Latch w/Handle **Save 10%**

• Order 6 or More Wood Gate Latch w/Handle **Save 20%**

## Commercial Heavy Duty Double Gate Flip Sentry Latch

- Double gate flip AKA "dumpster" latches are adjustable from 7/8" - 2-5/8" gap between gates.
- Mounting plates are each 1/4" in thickness and 4" x 4-1/2" dimension.
- Wrap around mounting plates allows for screws to be installed into side and front of mounts for a solid installation
- In most cases, when installing this latch on a double gate, a drop rod is not needed.
- Latch opens from one side of the gate so it is a great latch for dumpsters or

other gates where they are opened from one side.

- Black powder coated hardware looks great and increases product life and helps prevent rust.
- Simple to install with easy to follow installation instructions.
- Mounting screws are included

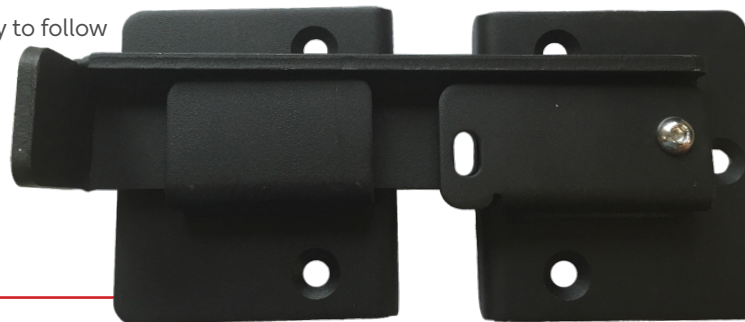

Discounts Apply To Purchase of 2 Or More of this Product

• Order 2 or More Wood Gate Latch w/Handle **Save 10%**

• Order 6 or More Wood Gate Latch w/Handle **Save 20%**



# WOOD FENCE ADAPTER & GATE HARDWARE

## 10" Black Decorative Wood Gate Pull Handle

- Sturdy construction 2" wide contemporary styled wood gate handle
- Manufactured from galvanized steel to withstand outdoor environments and resist rusting
- Black marine powder coated finish looks good and helps maintain long product life
- Wood gate handle measures 10-1/8" tip to tip with a 1-1/2" arched inside handle grip
- Easy to install - color matched mounting screws included

Discounts apply to any purchase of five (5) + of this product in course of the same order

- Order 5 or More Wood Fence Gate Handles and **Save 25%**

## 24" BRONZE Wood Fence Gate Drop Rod (AKA Drop Pin, Cane Bolt)

- Marine Powder Coated for product longevity
- Includes (1) Wood Gate Drop Rod & (2) Wood Gate Mounting Brackets
- Each Drop Rod Mounting Bracket is 3" High x 3" Wide x 1.5" in Depth
- Used with Double Gates to Hold one Stationary While the other Gate is Latched to it
- Measures 5/8" in diameter by 24" in length
- Cane Bolt Drop Pin Kit includes Mounting Bracket Guides for Wood Fence Gates - Color Matching Screws...

Discounts Apply to the purchase of Two (2) or more of this product in the course of the same order.

- Order 2 or more Wood Gate Drop Rod/Pins and **Save 10%**
- Order 6 or more Wood Gate Drop Rod/Pins and **Save 20%**

## 24" BLACK Wood Fence Gate Drop Rod (AKA Drop Pin, Cane Bolt)

- Used for Double Gates to Hold one Stationary While the other Gate is Latched to it
- Measures 1/2" diameter x 24" length - Drop Rod w/Mounting Brackets
- BLACK Powder Coated finish to Protect it From the Environment
- Product Contains Installation Instructions and Mounting Screws

Discounts Apply to the purchase of Two (2) or more of this product in the course of the same order.

- Order 2 or more Wood Gate Drop Rod/Pins and **Save 10%**
- Order 6 or more Wood Gate Drop Rod/Pins and **Save 20%**



# WOOD FENCE ADAPTER & GATE HARDWARE

## Western Style Black Single Wood Gate Kit (2-Hinges, 1- Latch)

- Includes 1 pair of hinges (2) wood gate hinges
  - Wood gate hinge measures 8" on each side of the center pin (16" total length)
  - Hinge measures 5" high at the highest point
  - Includes 1 wood gate latch
- (Operates from both sides)
  - Includes 1 wood gate handle (9" long)
  - BLACK powder coated finish for long gate hinge & latch life
  - Easy wood gate installation instructions included.
  - Includes matching screws

Discounts Apply to the purchase of Two (2) or more of this product in the course of the same order.

- Order 2 or more Single Wood Gate Kits (Hinges & Latch) and **Save 10%**
- Order 6 or more Single Wood Gate Kits (Hinges & Latch) and **Save 20%**

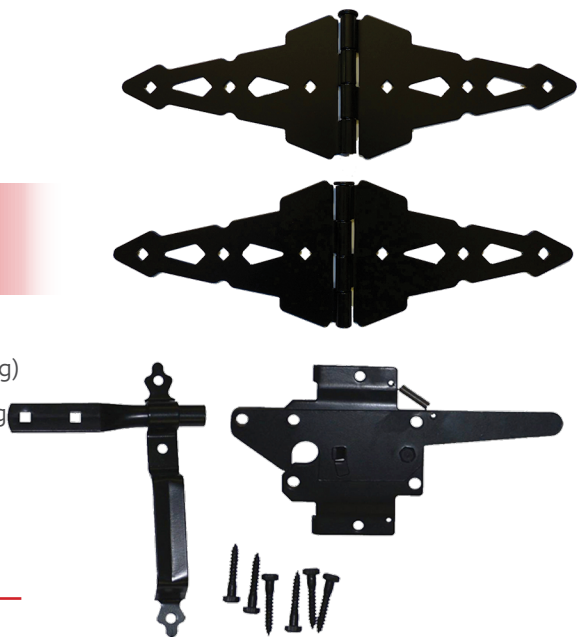

## Traditional Style Black Single Wood Gate Kit (2-Hinges, 1- Latch)

- Includes 1 pair of hinges (2) wood gate hinges
  - Wood gate hinge measures 8" on each side of the center pin (16" total length)
  - Hinge measures 5" high at the highest point
  - Includes 1 wood gate latch
- (Operates from both sides)
  - Includes 1 wood gate handle (9" long)
  - BLACK powder coated finish for long gate hinge & latch life
  - Easy wood gate installation instructions included.
  - Includes matching screws

Discounts Apply to the purchase of Two (2) or more of this product in the course of the same order.

- Order 2 or more Wood Gate Hinges, Latch w/Handle & Drop Rod/Pin and **Save 10%**
- Order 6 or more Wood Gate Hinges, Latch w/Handle & Drop Rod/Pin and **Save 20%**



## Western Style Bronze Single Wood Gate Kit (2-Hinges, 1- Latch)

- Includes 1 Pair of Hinges ((2) Wood Gate Hinges)
  - Wood Gate Hinge measures 8" on each side of the center pin (16" total length)
  - Hinge measures 5" high at the highest point
  - Includes 1 wood gate latch
- (Operates from both sides)
  - Includes 1 wood gate handle
  - Includes matching screws
  - Powder coated BRONZE finish for long hinge and latch life
  - Easy wood gate installation

Discounts Apply to the purchase of Two (2) or more of this product in the course of the same order.

- Order 2 or more Wood Gate Hinges, Latch w/Handle & Drop Rod/Pin and **Save 10%**
- Order 6 or more Wood Gate Hinges, Latch w/Handle & Drop Rod/Pin and **Save 20%**

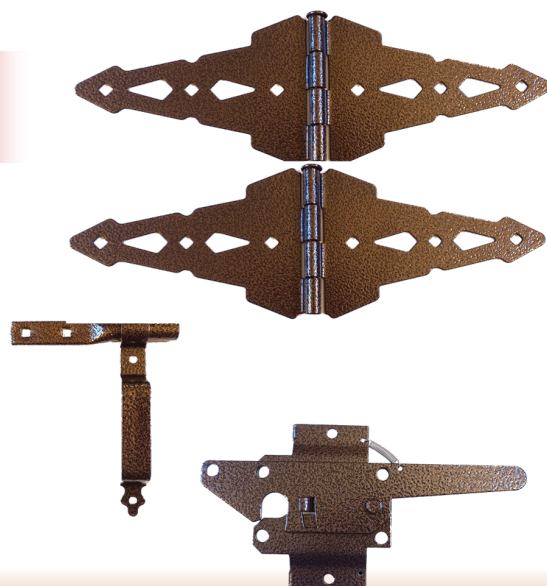

# WOOD FENCE ADAPTER & GATE HARDWARE

## Western Style Black Double Wood Gate Kit (Hinges, Latch & 24" Drop Rod)

- Includes 2 pair of hinges (FOUR wood gate hinges)
- Wood gate hinge measures 8" on each side of the center pin (16" total length)
- Hinge measures 5" high at the highest point
- Includes 1 wood gate latch (Operates from both sides)
- Includes 1 wood gate handle (9" Long)
- Includes 1 wood gate drop rod/pin (24" Long)
- Includes matching screws
- BLACK powder coated for long gate hinge, latch & drop rod life
- Easy wood gate installation



Discounts Apply to the purchase of Two (2) or more of this product in the course of the same order.

• Order 2 or More Wood Gate Hinges, Latch w/Handle & Drop Rod/Pin **Save 10%**

• Order 6 or More Wood Gate Hinges, Latch w/Handle & Drop Rod/Pin **Save 20%**

## Traditional Style Black Double Wood Gate Kit (Hinges, Latch & 24" Drop Rod)

- Includes 2 pair of hinges (FOUR wood gate hinges)
- Wood gate hinge measures 8" on each side of the center pin (16" total length)
- Hinge measures 5" high at the highest point
- Includes 1 wood gate latch (Operates from both sides)
- Includes 1 wood gate handle (9" Long)
- Includes 1 wood gate drop rod/pin (24" Long)
- Includes matching screws
- BLACK powder coated for long gate hinge, latch & drop rod life
- Easy wood gate installation

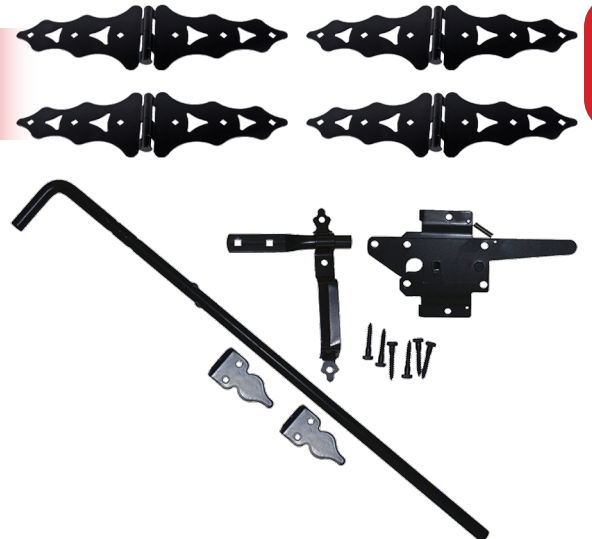

Discounts Apply to the purchase of Two (2) or more of this product in the course of the same order.

• Order 2 or More Wood Gate Hinges, Latch w/Handle & Drop Rod/Pin **Save 10%**

• Order 6 or More Wood Gate Hinges, Latch w/Handle & Drop Rod/Pin **Save 20%**

## Western Style Bronze Double Wood Gate Kit (Hinges, Latch & 24" Drop Rod)

- Includes 2 pair of hinges (FOUR wood gate hinges)
- Wood gate hinge measures 8" on each side of the center pin (16" total length)
- Hinge measures 5" high at the highest point
- Includes 1 wood gate latch (Operates from both sides)
- Includes 1 wood gate handle (9" Long)
- Includes 1 wood gate drop rod/pin (24" Long)
- Includes matching screws
- Powder coated for long gate hinge, latch & drop rod life
- Easy wood gate installation

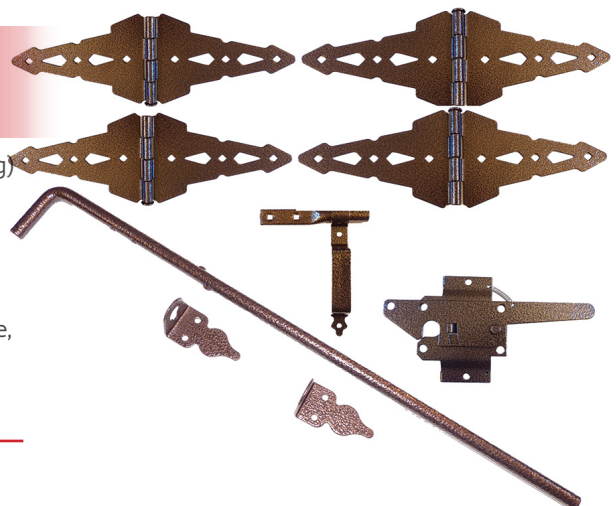

Discounts Apply to the purchase of Two (2) or more of this product in the course of the same order.

• Order 2 or More Wood Gate Hinges, Latch w/Handle & Drop Rod/Pin **Save 10%**

• Order 6 or More Wood Gate Hinges, Latch w/Handle & Drop Rod/Pin **Save 20%**



# WOOD FENCE ADAPTER & GATE HARDWARE

## 1-7/8" Steel Fence Post to Wood Fence Rail Bracket

- Allows wood fencing to be attached to steel fence posts
- Made of galvanized metal the product resists red rust due to environments with high humidity or moisture
- Product cradles the wood fence rail from underneath and has holes to allow for attaching fasteners to hold the rail firmly to the bracket.
- Slots for the clamp allow for an approximate 45 degree angle adjustment of the clamp
- Product comes with the U-Bolt and nuts included.



## 2-3/8" Steel Fence Post to Wood Fence Rail Bracket

- Allows wood fencing to be attached to steel fence posts
- Made of galvanized metal the product resists red rust due to environments with high humidity or moisture
- Product cradles the wood fence rail from underneath and has holes to allow for attaching fasteners to hold the rail firmly to the bracket.
- Slots for the clamp allow for an approximate 45 degree angle adjustment of the clamp
- Great for those replacing chain link fence with a nice looking wood fence as the steel posts can be reused.
- Product comes with the U-Bolt and nuts included.

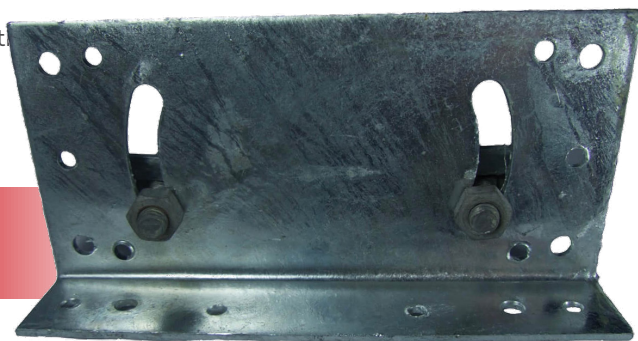

## Swivel Wheel for Swinging Wood Gate

- Easy to install Swivel Gate Wheel to Support the Weight of the Gate While Opening and Closing
- Bolt the Flat Sided Plate to the Flat Surface of the Gate
- Swivel Wheel can Help Support the Gate to Keep it from Sagging
- Made from Heavy Duty Galvanized Steel; Will Hold up Against Rusting
- Has a 6 Inch Wheel for Better Support and Smooth Operation.

Discounts Apply to the purchase of Four (4) or more of this product in the course of the same order.

- Order 4 or more Wood Gate Swivel Helper Wheel and Save 10%



# DEKTITE PIPE BOOT ROOF FLASHING

## SHR (DSR103B) Black Dektite SHR Asphalt Roofing Pipe Flashing

Discounts apply to any purchase of two (2) + of this product in course of the same order.

• Order 2 or More Dektite SHR Asphalt Pipe Flashings  
**Save 10%**

• Order 10 or More Dektite SHR Asphalt Pipe Flashings  
**Save 25%**

- Made from proprietary Polymer materials, compatible with Shingle (Asphalt) Roofing
- Unique self-sealing, no caulk design will maintain a minimum of 1/2" continuous contact with roof penetration to be flashed
- Large aluminum flange is designed

to provide ample fastening area and product stability

- Installs by sliding down pipe or cutting along zipper and using clips to reseal
- 20 Year Manufactures Warranty against Manufacturer Defects
- Easy to adjust size using clearly marked cutting grooves

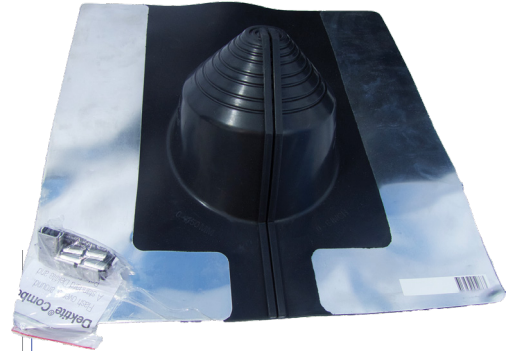

- Product is recognized by the bsi ISO 9001 Quality Management
- The DSR103B is designed to fit pipe with outside diameter from 1/4" to 4-1/2", base size of 15" x 15"

## Dekstrip - Flexible Roll Flashing 9" and 12" Wide

### SIZES

9" Wide X 5 Foot Long

9" x 75' FULL ROLL

12" Wide X 5 foot Long

12" x 75' FULL ROLL

Discounts apply to any purchase of two (2) + of this product in course of the same order.

• Order 2 or More Dekstrip 9" or 12" Full Rolls - **Save 3%**

• Order 6 or More Dekstrip 9" or 12" Full Rolls - **Save 5%**

- Dekstrip Flexible, Stretchable, Expandable... There is a built in aluminum strip into the EPDM on both sides.
- The strips are "concertina" (accordion) style. So they stretch out as you need them to up to 25% in length.
- Universal, adaptable flashing material you can flash round pipe, square or rectangular ducts, chimneys, skylights, irregular flues, and much more!
- Paintable: If you prime with epoxy resin-based primer, then you can paint

Dekstrip with 100% acrylic paint

- 20 Year Manufacturer Warranty Against Manufacturer Defects

Dekstrip is basically "Dektite-in-a-roll." Imagine being out on the job and coming up against an odd shaped object to flash around. No problem, with your roll of Dekstrip you can simply roll out and cut as you need.

And, even if you need to flash a typically shaped pipe or chimney but run out of time for ordering or picking something up at the store, if you have your roll of Dekstrip along you don't have to worry... just cut it, caulk it, and connect it.

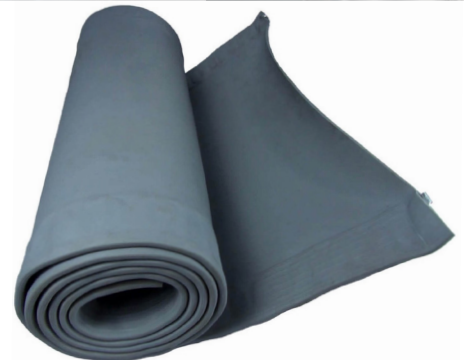

## HAVE QUESTIONS? NEED ANSWERS?

E-mail: [tom@jakesales.com](mailto:tom@jakesales.com)

Phone: (406) 752-5253

Website: [jakesales.com](http://jakesales.com)

[www.jakesales.com](http://www.jakesales.com)

# DEKTITE PIPE BOOT ROOF FLASHING

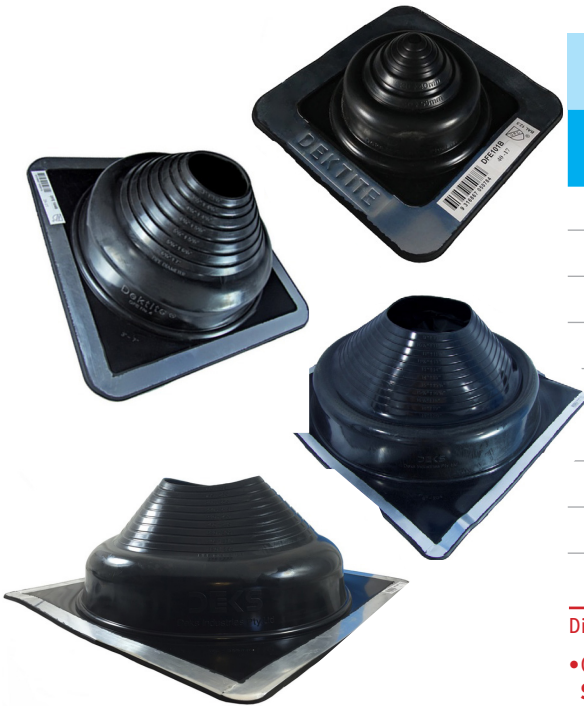

## Black Dektite Square EPDM Pipe Flashing

MODEL	Black Round Dektite Fits Pipes Measured by "Outside Diameter" of Pipe
DFE101B	Fits Pipes 1/4" to 2-1/4" with base of 5-1/2" x 5-1/2"
DFE102B	Fits Pipes 1/4" to 3" with base of 7" x 7"
DFE103B	Fits Pipes 1/4" to 5" with base of 8-3/4" x 8-3/4"
DFE104B	Fits Pipes 3" to 7" with base of 11" x 11"
DFE105B	Fits Pipes 4" to 8" with base of 12-1/4" x 12-1/4"
DFE106B	Fits Pipes 5" to 9" with base of 14-1/4" x 14-1/4"
DFE107B	Fits Pipes 6" to 12" with base of 18" x 18"
DFE108B	Fits Pipes 6-3/4" to 14" with base of 19-1/2" x 19-1/2"
DFE109B	Fits Pipes 9" to 20" with base of 26-3/4" x 26-3/4"

Discounts apply to any purchase of two (2) + of this product in course of the same order.

• Order 2 or More Dektite EPDM Pipe Flashing Boots  
**Save 10%**

• Order 10 or More Dektite EPDM Pipe Flashing Boots  
**Save 25%**

- Continuous Service Temperature Ranges of -58F to +239F (EPDM)
- Easily Customized Pipe Boot on the Job Site Using Heavy Scissors or Shears
- EPDM Rubber Boot with Flexible Base (Aluminum Collar) Pipe Flashing Will Not Break or Crack
- Reduced Building Maintenance due to Product Longevity
- Dektite Base Seals Against Uneven Metal Roofing with Ease.
- Use for Stove Pipes, Chimney, Plumbing, Heating,

- Air Conditioning, Electrical, Exhaust Vents, etc
- 20 Year Manufacturer's Warranty Against Manufacturing Defects
- Products are recognized by the bsi ISO 9001 Quality Management and the UPC IAPMO Uniform Plumbing Code
- For single wall chimney applications consider using a high temperature silicone flashing product that is rated for higher temperature applications.
- Installation Fasteners Available:  
25 Ct Flashing Screw Kit or  
35 Ct Flashing Screw Kit

- BLACK Dektite Square Base Pipe Flashings are for Roof Pitches up to 12/12 or 45. Note: When used on roofs where the pitch is steeper than 20 degrees, or when used on deep ribbed profile roof panels (1-1/2" deep corrugation or more), consider using the next size larger Dektite that will accommodate the same diameter pipe.
- **CAUTION!** This product is not rated for temperatures experienced by prolonged contact with a single wall chimney. Failure to follow the products stated directions and specifications for use may result in damage to the Dektite and other items nearby.



## Gray Dektite Retrofit EPDM Pipe Flashings

MODEL	Black Round Dektite Fits Pipes Measured by "Outside Diameter" of Pipe
DF801G	Fits Pipe 3/4" to 2-3/4"
DF802G	Fits Pipe 2" to 7-1/4"
DF803G	Fits Pipe 3-1/4" to 10"

Discounts apply to any purchase of two (2) + of this product in course of the same order.

• Order 2 or More Dektite EPDM Pipe Flashing Boots  
**Save 10%**

• Order 10 or More Dektite EPDM Pipe Flashing Boots  
**Save 25%**



# DEKTITE PIPE BOOT ROOF FLASHING



## Black Dektite Round Standard Flexible Pipe Flashing

MODEL	Black Round Dektite Fits Pipes Measured by "Outside Diameter" of Pipe
DF100B EDMP	Fits Pipes 0" to 1-3/8" with base of 3-3/4"
DF101B EDMP	Fits Pipes 1/4" to 2-1/2" with base of 4-3/4"
DF102B EDMP	Fits Pipes 1-3/4" to 3-1/4" with base of 6-1/2"
DF103B EDMP	Fits Pipes 1/4" to 5" with base of 8"
DF104B EDMP	Fits Pipes 3" to 6-1/4" with base of 9-1/2"
DF105B EDMP	Fits Pipes 4-1/4" to 7-1/2" with base of 11"
DF106B EDMP	Fits Pipes 5" to 9" with base of 12-3/4"
DF107B EDMP	Fits Pipes 6" to 11" with base of 14-3/4"
DF108B EDMP	Fits Pipes 7" to 13" with base of 16-3/4"

Discounts apply to any purchase of two (2) + of this product in course of the same order.

• Order 2 or More Dektite EPDM Pipe Flashing Boots  
**Save 10%**

• Order 10 or More Dektite EPDM Pipe Flashing Boots  
**Save 25%**

- Continuous service temperature ranges of -58F to +239F (EPDM)
- Easily customized pipe boot on the job site using heavy scissors or shears
- Unique cone design provides continuous contact with flashed pipe providing watertight seal
- EPDM Rubber Boot with flexible base (Aluminum Collar)
- Dektite Base seals against uneven metal roofing, pipe flashing will not break or crack
- Reduced building maintenance due to

product longevity

- Flashing base fastener spacing: 1-1/2"
- Use for stove pipes, chimney, plumbing, heating, air conditioning, electrical, exhaust vents, etc.
- 20 Year Manufacturer's Warranty against manufacturing defects
- Recognized by the bsi ISO 9001 Quality Management and UPC IAPMO Uniform Plumbing Code Organizations
- For single wall chimney applications consider using a high temperature silicone flashing product that is rated for higher

temperature applications.

- On a roof with a 10/12 to 12/12 pitch Dektite recommends you use a Squarebase pipe flashing installed with the tip pointed towards roof top. When used with deep ribbed profile panels (1-1/2" deep corrugation or more), consider using the next size up that will accommodate the same diameter pipe.
- **CAUTION!** This product is not rated for temperatures experienced by prolonged contact with a single wall chimney. Failure to follow the products stated directions and specifications for use may result in damage to the Dektite and other items nearby.

- Continuous Service Temperature Ranges of -58F to +239 F (EPDM)
- Easily Customized Pipe Boot on the Job Site using Heavy Scissors or Shears
- EPDM Rubber Boot with Flexible Base (Aluminum Collar)
- Dektite Base Seals Against Uneven Metal Roofing with Ease, Pipe Flashing Will Not Break or Crack
- Reduced Building Maintenance due to Product Longevity
- Flashing Base Fastener Spacing: 1-1/2"
- Use for Stove Pipes, Chimney, Plumbing, Heating, Air Conditioning, Electrical,

Exhaust Vents, etc.

- 20 Year Manufacturer's Warranty Against Manufacturing Defects
- Products are recognized by the bsi ISO 9001 Quality Management and the UPC IAPMO Uniform Plumbing Code
- On a roof with a 10/12 to 12/12 pitch Dektite recommends you use a Square base pipe flashing installed with the tip pointed towards roof top. When used with deep ribbed profile panels (1-1/2" deep corrugation or more), consider using the next size up that will accommodate the same diameter pipe.

- **Caution!** This product is not rated for temperatures experienced by prolonged contact with a single wall chimney. Failure to follow the products stated directions and specifications for use may result in damage to the Dektite and other items nearby.
- For single wall chimney applications consider using a high temperature silicone combo/retrofit flashing product that is rated for higher temperature applications.
- Installation Fasteners Available 25 Count Flashing Screw Kit or 35 Count Flashing Screw Kit

# DEKTITE PIPE BOOT ROOF FLASHING



## Red Dektite Round Base Silicone High Temp Pipe Boot Flashings

MODEL	Red Round Dektite Fits Pipes Measured by "Outside Diameter" of Pipe
DF201RE	#1 Fits 1/4" to 2-1/2" Pipe Diameter - with base of 4-3/4"
DF202RE	#2 Fits 1-3/4" to 3-1/4" Pipe Diameter - with base of 6-1/2"
DF203RE	#3 Fits 1/4" to 5" Pipe Diameter - with base of 7-3/4"
DF204RE	#4 Fits 3" to 6-1/4" Pipe Diameter - with base of 9-1/2"
DF205RE	#5 Fits 4" to 7" Pipe Diameter - with base of 10-3/4"
DF206RE	#6 Fits 5" to 9" Pipe Diameter - with base of 12-1/2"
DF207RE	#7 Fits 6" to 11" Pipe Diameter - with base of 14-1/2"
DF208RE	#8 Fits 7" to 13" Pipe Diameter - with base of 16-1/2"

Discounts apply to any purchase of two (2) + of this product in course of the same order.

• Order 2 or more Dektite High Temp Pipe Flashing Boots - **Save 10%**

• Order 10 or more Dektite High Temp Pipe Flashing Boots - **Save 25%**

- Easily Customized Pipe Boot on the Job Site Using Heavy Scissors or Shears
- Red Silicone Pipe Boot with Flexible Base (Aluminum Collar)
- Dektite Base Seals Against Uneven Metal Roofing with Ease, Pipe Flashing Will Not Break or Crack
- Continuous Service Temperature Ranges of -58°F to +392°F
- Reduced Building Maintenance due to Product Longevity

- Flashing Base Fastener Spacing: 1-1/2"
- Use for Stove Pipes, Chimney Pipes, Plumbing Pipes, Heating Pipes, Air Conditioning Pipes, Electrical Conduits, Exhaust Vent Pipes, etc.
- 20 Year Manufacturer's Warranty Against Manufacturing Defects
- Products are recognized by the bsi ISO 9001 Quality Management and the UPC IAPMO Uniform Plumbing Code
- Manufacturers recommended temperature ranges are clearly stated! Please verify this product will meet specifications of

your installation or possible product and structural damage may occur

- Installation Fasteners Available Here: 25 Count Flashing Screw Kit or 35 Count Flashing Screw Kit
- On a roof with a 10/12 to 12/12 pitch Dektite recommends you use a Squarebase pipe flashing installed with the tip pointed towards roof top. When used with deep ribbed profile panels (1-1/2" deep corrugation or more), consider using the next size up that will accommodate the same diameter pipe.



## Dektite High Temperature Combo / Retrofit Square Base Pipe Flashing

MODEL	Red Round Dektite Fits Pipes Measured by "Outside Diameter" of Pipe
DC201REC	#1 Combo fits pipes from 1-4" to 2-1/2"- with a base of 5-1/2" x 5-1/2"
DC202REC	#2 Combo fits pipes from 1-3/4" to 3-1/4"- with a base of 7" x 7"
DC203REC	#3 Combo fits pipes from 1/4" to 5"- with a base size of 8-3/4" x 8-3/4"
DC204REC	#4 Combo fits pipes from 3" to 7"- with a base size of 11-1/4" x 11-1/4"
DC205REC	#5 Combo fits pipes from 4-1/4" to 7-1/2"- with a base size of 14-1/4" x 14-1/4"
DC206REC	#6 Combo fits pipes from 5" to 9"- with a base size of 14-1/4" x 14-1/4"
DC207REC	#7 Combo fits pipes from 6" to 11"- with a base size of 17-3/4" x 17-3/4"
DC208REC	#8 Combo fits pipes from 7" to 13"- with a base size of 17-3/4" x 17-3/4"

# DEKTITE PIPE BOOT ROOF FLASHING

## Red Dektite Square Base Silicone High Temp Pipe Flashings

MODEL	Red Square Dektite Fits Pipes Measured by "Outside Diameter" of Pipe
DFE201RE	Fits 1/4" to 2-1/4" Pipe Diameter - with base of 5-1/2" x 5-1/2"
DFE202RE	Fits 1/4" to 3" Pipe Diameter - with base of 7" x 7"
DFE203RE	Fits 1/4" to 5" Pipe Diameter - with base of 8-3/4" x 8-3/4"
DFE204RE	Fits 3" to 7" Pipe Diameter - with base of 11" x 11"
DFE205RE	Fits 4" to 8" Pipe Diameter - with base of 12-1/4" x 12-1/4"
DFE206RE	Fits 5" to 9" Pipe Diameter - with base of 14-1/4" x 14-1/4"
DFE207RE	Fits 6" to 12" Pipe Diameter - with base of 18" x 18"
DFE208RE	Fits 6-3/4" to 14" Pipe Diameter - with base of 19-1/2" x 19-1/2"
DFE209RE	Fits 9" to 20" Pipe Diameter - with base of 26-3/4" x 26-3/4"



Discounts apply to any purchase of two (2) + of this product in course of the same order.

- Order 2 or more Dektite High Temp Pipe Flashing Boots - **Save 10%**
- Order 10 or more Dektite High Temp Pipe Flashing Boots - **Save 25%**

- Easily Customized Pipe Boot on the Job Site using heavy scissors or shears
- Red Silicone Pipe Boot with Flexible Base (Aluminum Collar)
- Dektite Base Seals Against Uneven Metal Roofing with Ease, Pipe Flashing Will Not Break or Crack
- Continuous Service Temperature Ranges of -58°F to +392°F
- Reduced Building Maintenance due to product longevity
- Flashing Base Fastener Spacing: 1-1/2"
- Use for Stove Pipes, Chimney Pipes, Plumbing Pipes, Heating Pipes, Air Conditioning Pipes, Electrical Conduits, Exhaust Vent Pipes, etc.
- 20 Year Manufacturer's Warranty Against Manufacturing Defects
- Products are recognized by the bsi ISO 9001 Quality Management and the UPC IAPMO Uniform Plumbing Code
- Manufacturers recommended temperature ranges are clearly stated! Please verify this product will meet specifications of your installation or possible product and structural damage may occur
- Installation Fasteners Available: 25 Count Flashing Screw Kit or 35 Count Flashing Screw Kit
- Red Dektite Square Base Pipe Flashings are for Roof Pitches up to 12/12 or 45 degrees.
- On a roof with a 10/12 to 12/12 pitch Dektite recommends you use a Square base pipe flashing installed with the tip pointed towards roof top. When used with deep ribbed profile panels (1-1/2" deep corrugation or more), consider using the next size up that will accommodate the same diameter pipe

- This Dektite Product is Unique in Design. Can be Installed Like Standard Pipe Flashing.
- Or Where the Height of the Pipe is Hard to Reach, Cut Along Seam and Reseal With Provided Clips.
- Rated for High Temperature with Continuous Service Temperature Ranges of -58°F to +392°F Red Silicone
- Silicone Rubber with Flexible Base (Aluminum Collar) Seals Against Uneven Metal Roofing, Will Not Break or Crack
- Use for Stove Pipes, Chimney, Plumbing, Heating, Air Conditioning, Electrical, Exhaust Vents.
- Product Comes With a 20 Year Manufacturer's Warranty Against Manufacturing Defects
- Easily Customized on Site using Heavy Scissors or Shears.
- Products are recognized by the bsi ISO 9001 Quality Management and the UPC IAPMO Uniform Plumbing Code
- Manufacturers recommended temperature ranges are clearly stated! Please verify this product will meet specifications of your installation or possible product and structural damage may occur
- Fasteners Available Here: 25 Count Flashing Screw Kit or 35 Count Flashing Screw Kit
- On a roof with a 10/12 to 12/12 pitch Dektite recommends you use a Squarebase pipe flashing installed with the tip pointed towards roof top. When used with deep ribbed profile panels (1-1/2" deep corrugation or more), consider using the next size up that will accommodate the same diameter pipe.

Discounts apply to any purchase of two (2) + of this product in course of the same order.

- Order 2 or more Dektite High Temp Pipe Flashing Boots - **Save 10%**
- Order 10 or more Dektite High Temp Pipe Flashing Boots - **Save 25%**



# DEKTITE PIPE BOOTS AND ROOF FLASHING



## Gray Dektite Round Base HIGH TEMP Silicone Pipe Boot Flashings

MODEL	Gray Round Dektite Fits Pipes Measured by "Outside Diameter" of Pipe
DF203G	#3 Fits 1/4" to 5" Pipe Diameter - with base of 8"
DF204G	#4 Fits 3" to 6-1/4" Pipe Diameter - with base of 9-1/2"
DF205G	#5 Fits 4-1/4" to 7-1/2" Pipe Diameter - with base of 11"
DF206G	#6 Fits 5" to 9" Pipe Diameter - with base of 12-3/4"
DF207G	#7 Fits 6" to 11" Pipe Diameter - with base of 14-3/4"
DF208G	#8 Fits 7" to 13" Pipe Diameter - with base of 16-3/4"
DF209G	#9 Fits 10" to 19" Pipe Diameter - with base of 25-1/2"

Discounts apply to any purchase of two (2) + of this product in course of the same order.

- Order 2 or more Dektite High Temp Pipe Flashing Boots - **Save 10%**
- Order 10 or more Dektite High Temp Pipe Flashing Boots - **Save 25%**

- Continuous service High Temperature ranges of -58F to 392F (Silicone)
- Easily customize pipe boot size on the job site with shears or heavy scissors
- Silicone Rubber Boot with flexible base (Aluminum Collar) seals against uneven metal roofing
- Slide flashing down pipe and fasten aluminum collar to roof with metal roofing screws every 1-1/2"

- If trimmed and installed correctly, pipe flashing will not break or crack
  - 20 Year Manufacturer's Warranty against manufacturing defects
  - Works with metal roof pitches up to 10/12 (0 to 40 degrees) \*\*
- \*\* On a roof with a 10/12 to 12/12 (45 Degrees) pitch Dektite recommends you use a Square Base Pipe Flashing installed with the base tip pointed towards roof top. When used with

deep ribbed profile roofing panels with 1-1/2" deep corrugation or more, consider using next size up that will accommodate the same diameter pipe.

Manufacturers recommended temperature ranges are clearly stated.

**Please verify this product will meet specifications of your installation or possible product damage may occur.**

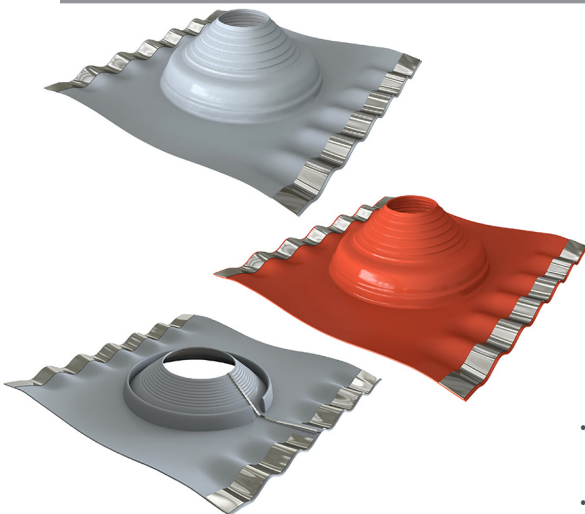

## Dektite Diverter R-Panel Flashing for Low or High Profile Roofing

MODEL	Dektite Fits Pipes Measured by "Outside Diameter" of Pipe
DF602-EPDM	Fits pipes from 3" to 6"- with a base of 16" x 14"
DF603-EPDM	Fits pipes from 4-1/2" to 10"- with a base of 19" x 18"
DF605-EPDM	Fits pipes from 10" to 16"- with a base of 28" x 35-5/8"
DF606-EPDM	Fits pipes from 15" to 24"- with a base of 39-1/2" x 35-5/8"
DF706-SILICONE	Fits pipes from 15" to 24"- with a base of 39-1/2" x 35-5/8"

- Two Different Styles - High Temperature Silicon and Gray Lower Temperature EPDM
- EPDM will withstand constant temperatures at the roof line of -58F to 239F
- Designed for High and Low Deep Ridge Roof Pitches - 0 to 60 Degrees or 18/12 - R-Panel Roofing
- 20 Year Warranty against manufacturing defects If measured and installed correctly
- No ponding or damming - large base reduces rain and snow back up
- Red Silicone will withstand constant temperatures at the roof line of -50C (-58F) to 200C (392F)

Discounts apply to any purchase of two (2) + of this product in course of the same order.

- Order 2 or more Dektite High Temp Pipe Flashing Boots - **Save 10%**
- Order 10 or more Dektite High Temp Pipe Flashing Boots - **Save 25%**

# DEKTITE PIPE BOOT ROOF FLASHING



- Dektite Metal Roof Flashing in Round Base
- EPDM pipe flashing are good for low temperature applications of continuous service range from -58F to 239F
- 20 Year Manufacturer's Warranty against manufacturing defects
- If trimmed and installed correctly, pipe flashing will not break or crack
- Use for stove pipes, chimneys, plumbing, heating, air conditioning, electrical and exhaust vents

Works with metal roof pitches up to 10/12 (0 to 40 degrees)

On a roof with a 10/12 to 12/12 pitch Dektite recommends you use a square base pipe flashing installed with the base tip pointed towards roof top.

When used with deep ribbed profile roofing panels with 1-1/2" deep corrugation or more, consider using next size up that will accommodate the same diameter pipe.

**Caution:** This product is not rated for temperatures experienced by prolonged contact with a single wall chimney.

Manufacturers recommended temperature ranges are clearly stated. Please verify this product will meet specifications of your installation or possible product damage may occur. For single wall chimney applications consider using a High Temperature Silicone Flashing product that is rated for high temperature applications

*If you have any questions about use and application please call our Customer Service Center at 406-752-5253 ext. 1*

Discounts apply to any purchase of two (2) + of this product in course of the same order.

- Order 2 or more Dektite High Temp Pipe Flashing Boots - **Save 10%**
- Order 10 or more Dektite High Temp Pipe Flashing Boots - **Save 25%**

## Dektite Round Base Pipe Flashings (various colors)

MODEL	Dektite Fits Pipes Measured by "Outside Diameter" of Pipe
<b>BROWN</b>	
DF103BN	Fits 1/4" to 5" Pipe Diameter - with base of 8"
DF105BN	Fits 4-1/4" to 7-1/2" Pipe Diameter - with base of 11"
DF108BN	Fits 7" to 13" Pipe Diameter - with base of 16-3/4"
<b>BRIGHT RED</b>	
DF103BR	Fits 1/4" to 5" Pipe Diameter - with base of 8"
DF105BR	Fits 4-1/4" to 7-1/2" Pipe Diameter - with base of 11"
DF108BR	Fits 7" to 13" Pipe Diameter - with base of 16-3/4"
<b>DARK BLUE</b>	
DF103DB	Fits 1/4" to 5" Pipe Diameter - with base of 8"
DF105DB	Fits 4-1/4" to 7-1/2" Pipe Diameter - with base of 11"
DF108DB	Fits 7" to 13" Pipe Diameter - with base of 16-3/4"
<b>DARK GREEN</b>	
DF103DG	Fits 1/4" to 5" Pipe Diameter - with base of 8"
DF105DG	Fits 4-1/4" to 7-1/2" Pipe Diameter - with base of 11"
DF108DG	Fits 7" to 13" Pipe Diameter - with base of 16-3/4"
<b>LIGHT BLUE</b>	
DF103LB	Fits 1/4" to 5" Pipe Diameter - with base of 8"
DF105LB	Fits 4-1/4" to 7-1/2" Pipe Diameter - with base of 11"
DF108LB	Fits 7" to 13" Pipe Diameter - with base of 16-3/4"
<b>LIGHT GREEN</b>	
DF103LG	Fits 1/4" to 5" Pipe Diameter - with base of 8"
DF105LG	Fits 4-1/4" to 7-1/2" Pipe Diameter - with base of 11"
DF108LG	Fits 7" to 13" Pipe Diameter - with base of 16-3/4"
<b>TERRACOTTA</b>	
DF103TC	Fits 1/4" to 5" Pipe Diameter - with base of 8"
DF105TC	Fits 4-1/4" to 7-1/2" Pipe Diameter - with base of 11"
DF108TC	Fits 7" to 13" Pipe Diameter - with base of 16-3/4"
<b>WHITE</b>	
DF103WH	Fits 1/4" to 5" Pipe Diameter - with base of 8"
DF105WH	Fits 4-1/4" to 7-1/2" Pipe Diameter - with base of 11"
DF108WH	Fits 7" to 13" Pipe Diameter - with base of 16-3/4"

# DEKTITE PIPE BOOT ROOF FLASHING



## Dektite SHT Shingle Roof Pipe Flashing

MODEL	Dektite SHT Pipe Flashing Fits Pipes Measured by "Outside Diameter" of Pipe
DST101B	Fits 1-1/4" to 1-1/2" Pipe Diameter - with a base of 13" x 9-1/4"
DST103B	Fits 3" Pipe Diameter - with a base of 15" x 11-1/4"
DST104B	Fits 4" Pipe Diameter - with a base of 16" x 12"



- Shingle Roof Pipe Flashing manufactured in Thermoplastic Hard Base with Elastomer Collar
- No Caulk - Self Sealing base
- Fits any roof pitch from 45 degrees. Withstands heat to 180 degrees fahrenheit
- Approved for Type-B installations. UPC Approved.

Discounts apply to any purchase of two (2) + of this product in course of the same order.

- Order 2 or More Dektite SHR/SHT Asphalt Pipe Flashings and - **Save 10%**
- Order 10 or More Dektite SHR/SHT Asphalt Pipe Flashings and - **Save 25%**



## Dektite Self-adhesive Fast Flash Flashing For Most Roofing Materials

11" x 16 Feet Polymer Roll

22" x 16 Feet Polymer Roll

- Dimensions - 11" x 16 Feet - and 22" x 16 Feet - Trim to Size Self Adhesive Roof Flashing Roll
- Lead Free adhesive roof flashing rolls, suitable for tile, metal, poly carbonate and fiberglass
- Consists of aluminum stretch netting cast in environmentally friendly polymer rubber.
- Slow set time of the adhesive allows for repositioning - Malleable and stretchable for all profiles
- Easy to Install, is lightweight and easy to trim. Fully self adhesive.

### SELF-ADHESIVE FLASHING FOR ANY ROOFING PROJECT

Fast Flash is ideal for anywhere requiring a quick and secure flashing solution. Fast Flash can be installed on roofs with a slope of minimum 5° and on almost all roof materials. Fast Flash is environmentally friendly and easy to install, as the reverse is self-adhesive, as well as being flexible and very workable.

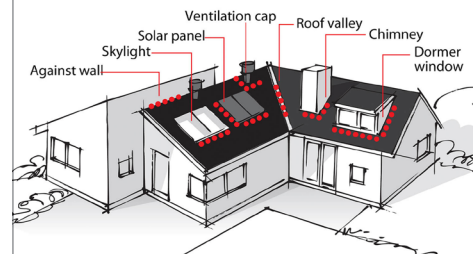

## HAVE QUESTIONS? NEED ANSWERS?

E-mail: [tom@jakesales.com](mailto:tom@jakesales.com)

Phone: (406) 752-5253

Website: [jakesales.com](http://jakesales.com)





# DEKTITE PIPE COUPLERS

## DEKS - Joiners Flexible Couplings

MODEL	Dektite Couplers Measured by "Outside Diameter" of Pipe
<b>DX156-22</b>	2" to 2" Coupling Cast Iron or Plastic (PVC) to Cast Iron or Plastic
<b>DX156-33</b>	3" to 3" Coupling Cast Iron or Plastic (PVC) to Cast Iron or Plastic
<b>DX156-44</b>	4" TO 4" Coupling Cast Iron or Plastic (PVC) to Cast Iron or Plastic
<b>DX1002-44</b>	4" to 4" Coupling Clay to Plastic (PVC) or Cast Iron
<b>DX1002-66</b>	6" to 6" Coupling Clay to Plastic (PVC) or Cast Iron

- **DX156 couplings** are for connecting Cast Iron or Plastic (PVC) to Cast Iron or Plastic (PVC) pipe
- **DX1002 couplings** are for connecting Clay to Cast Iron, or Plastic (PVC) pipe
- Have been engineered by Deks to provide a leak proof seal connection on many pipe materials.
- Applications include, but are not limited to sewer and in house connections
- Seals against infiltration and exfiltration, drain, waste, vent piping, house to main, retrofit, repairs, roof drains and cut ins
- Further, Joiners are resistant to chemicals, ultraviolet rays, normal sewer gas, fungus growth and root resistant



## DEKS - Joiners SR Stainless Steel Couplings (Non-Shear Shield with Four Gear Bands)

MODEL	Dektite Couplers Measured by "Outside Diameter" of Pipe
<b>DX1002-44SR</b>	4" to 4" Coupling Clay to Cast Iron or Plastic (PVC)
<b>DX1002-66SR</b>	6" to 6" Coupling Clay to Cast Iron or Plastic (PVC)
<b>DX1056-44SR</b>	4" TO 4" Coupling Cast Iron or Plastic (PVC) to Cast Iron or Plastic (PVC)
<b>DX1056-66SR</b>	6" TO 6" Coupling Cast Iron or Plastic (PVC) to Cast Iron or Plastic (PVC)

- **DX1002SR** couplings are for connecting Clay to Cast Iron, or Plastic (PVC) pipe
- **DX1056SR** couplings are for connecting Cast Iron or Plastic (PVC) to Cast Iron or Plastic (PVC) pipe
- Underground and Repair couplings engineered by Deks provides a strong coupling, resistance to heavy earth loads, shear forces and improved pipe alignment
- Thickness of the clamp & shield, in

conjunction with the additional width of the coupling result in a more uniformly rigid joint

- Additional sealing clamps provide increased surface bearing contact between the coupling and the pipe or fittings
- Gasket: Elastomeric PVC material formulated and manufactured to meet the requirements of ASTM C1173, ASTM D5926 and CSA B602



# DEKTITE PIPE COUPLERS

## DEKS Joiners SS No Hub Couplings

MODEL	Dektite Couplers Measured by "Outside Diameter" of Pipe
<b>DXNH156-150 - SS No Hub</b>	1-1/2" to 1-1/2" Connecting No Hub Cast Iron Pipe or Plastic (PVC)
<b>DXNH156-22 - SS No Hub</b>	2" to 2" Connecting No Hub Cast Iron Pipe or Plastic (PVC)
<b>DXNH156-33 - SS No Hub</b>	3" to 3" Connecting No Hub Cast Iron Pipe or Plastic (PVC)
<b>DXNH156-44 - SS No Hub</b>	4" to 4" Connecting No Hub Cast Iron Pipe or Plastic (PVC)

- **DXNH SS No Hub** couplings are for connecting "No Hub Cast Iron pipe, or Plastic (PVC) pipe
- Joiner SS No Hub Couplings (DXNH) has been engineered by Deks to join hubless cast iron pipe and fittings
- These couplings consist of a 301 stainless shield in conjunction with stainless steel clamps
- The stainless steel shield and clamps are corrosion resistant
- Gaskets are manufactured from a properly vulcanized virgin compound, primary elastomer is polychloroprene (neoprene) conforming to ASTM C 564
- Join Cast Iron pipe, PVC., Steel, Copper, and tubular drain waste and vent systems

## DEKS J-Tite Service Weight Soil Gasket - 4"

### DXD44 - Pipe Gasket 4"

- Used for Joining Hub and Spigot Cast Iron Pipe
- Durable Molded One Piece Neoprene Rubber
- Multiple Outside Rings for Excellent Sealing
- Conforms to ASTM C564
- Available in Sizes from 2" to 8" - Special Order Only

## DEKS Joiners End Caps

### DACAP2 - 2" CAP

### DACAP4 - 4" CAP

- DEKS end caps are made from the same high flexible rubber polymer as the joiners for extreme durability.
- End caps are for use in residential applications for capping pipe ends during testing or clean outs,
- Also in non-pressure applications (drains, soil waste pipe connections)





## Warranty on Dektite Pipe Flashing

This warranty on Dektite Pipe Flashing is given by DEKS Industries Pty Ltd 5/841 Mountain Hwy, Bayswater 3153, Victoria, Australia ("DEKS"), for the periods and under the terms and conditions listed below;

1. DEKS warrants that all Dektite Pipe Flashings ('the Products') furnished, will perform in accordance with our published specifications and will be free from defects in material and workmanship for a maximum period of 20 years, commencing from the date of delivery to the end user. Under this warranty DEKS will, at its option, repair or replace any defective Products. Any claim should be made in writing within 60 days following the discovery of any defect. DEKS shall not be liable for any costs incurred in the removal of defective items or installation of replacement items nor cost of freight and other associated charges.
2. The warranty does not apply if:
  - (a) the Product has not been installed in strict accordance with our published recommendations;
  - (b) the Product has been installed in an area which has been exposed at any time during the warranty period to corrosive conditions including but not limited to, corrosive chemicals, ash, fumes or condensates or harmful substance generated within or about the building(s) or fixture(s) to which the Product has been applied;
  - (c) any damage to the Product has been caused as a result of the negligence or misuse of the Product by the claimant.
  - (d) any modification to the specification of the Product has been made, save and except where any modification is reasonably necessary in adapting the Product to size.
  - (e) defects in the Product are a result of mechanical or chemical damage, which occurred during shipment or storage prior to use;
  - (f) defects are a result of natural hazards or other external forces, including but not limited to, failure to provide free drainage of water from around the areas in which the Product has been installed.
3. To the extent permitted by law, this warranty is given in lieu of all other warranties, express or implied, including any warranty of merchantability or fitness for a particular purpose. Where so permitted, the remedies stated herein are exclusive remedies and DEKS shall not be responsible for any indirect, consequential or incidental damages or further loss of any kind whatsoever except as expressly provided by in this Warranty.
4. This warranty is in addition to your rights under the Australian Consumer Law. Our goods come with guarantees that cannot be excluded under the Australian Consumer Law. You are entitled to a replacement or refund for a major failure and for compensation for any other reasonably foreseeable loss or damage. You are also entitled to have the goods repaired or replaced if the goods fail to be acceptable quality and the failure does not amount to a major failure.



**USUALLY WITHIN 24 HOURS**  
(Excludes Weekends, Holidays or Special Orders)

# 20 YEAR WARRANTY

## ON ALL DEKTITE PRODUCTS





# CHAIN LINK FENCE HARDWARE

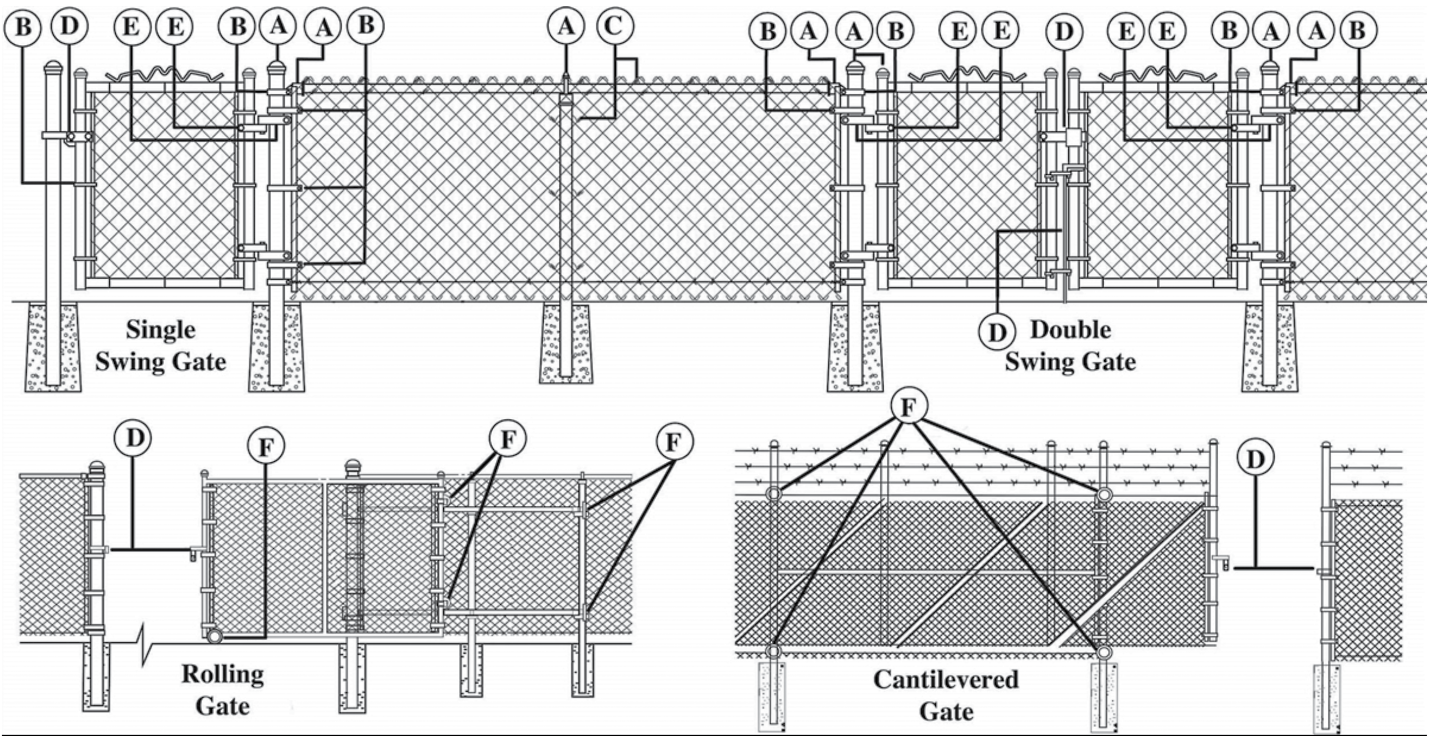

## PARTS BELOW CORRESPOND TO THE LETTERS ABOVE

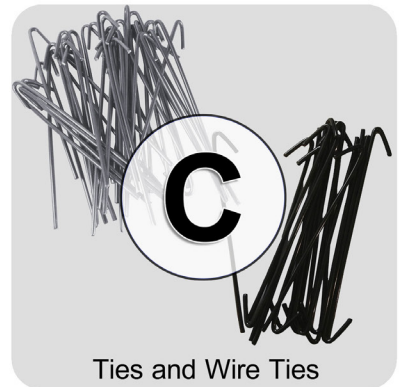
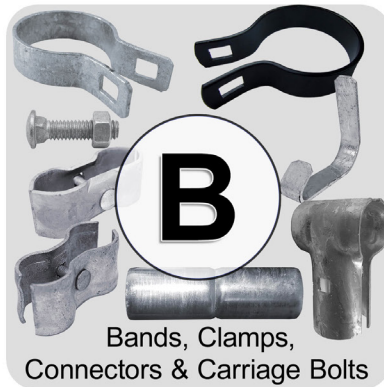

# CHAIN LINK FENCE HARDWARE

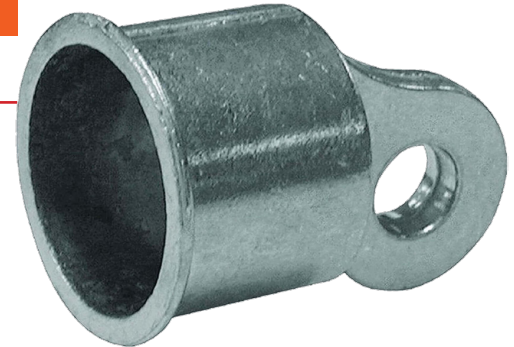

## Pressed Steel Chain Link Top Rail End

### SIZES

1-3/8" Pressed Steel

1-7/8" Pressed Steel

1-5/8" Pressed Steel

2-3/8" Pressed Steel

Discounts apply to any purchase of two (2) + of this product in course of the same order.

- Order 2 or More Chain Link Rail Ends and Save 35%
- Order 7 or More Chain Link Rail Ends and Save 45%
- For applications where 1-3/8" to 2-3/8" Outside Diameter Chain Link Fence Top Rail pipe is used
- Used to attach a chain link top rail to a terminal, corner fence, end fence or gate fence post or gate frame pipe using a Brace Band
- Top Rail End Goes Between the Brace Bands and the Top Rail Holding the Chain Link Top Rail in Place
- Pressed Steel Finish Prevents Rust and Adds to Product Longevity
- **Please Measure Top Rail Outside Diameter Before Ordering, not all rails are the same measure.**

## Aluminum Chain Link Top Rail End

### SIZES

1-3/8" Aluminum

1-5/8" Aluminum

Discounts apply to any purchase of two (2) + of this product in course of the same order.

- Order 2 or More Chain Link Rail Ends and Save 35%
- Order 7 or More Chain Link Rail Ends and Save 45%
- For applications where 1-3/8" & 1-5/8" Outside Diameter Chain Link Fence Top Rail pipe is used
- Use to attach chain link top rail to a terminal, corner fence, end fence or gate fence post and gate frame pipe
- Top Rail End is Made From Durable Aluminum to Prevent Red Rust.
- Top Rail End Goes Between the Brace Bands and the Top Rail Holding the Chain Link Top Rail in Place
- Rail End are Also Used to Put a Pipe Along the Bottom of a Fence.
- **Please Pre-Measure Your Top Rail Pipe Prior to Ordering. Not All Pipes are the Same**

## Black Powder Coated Chain Link Top Rail End

### SIZES

1-3/8" Black

1-5/8" Black

Discounts apply to any purchase of two (2) + of this product in course of the same order.

- Order 2 or More Chain Link Rail Ends - BLACK and Save 35%
- Order 7 or More Chain Link Rail Ends - BLACK and Save 45%
- For applications where 1-3/8" or 1-5/8" Outside Diameter Chain Link Fence Top Rail pipe is used
- Used to attach chain link top rail to a terminal, corner fence, end fence or gate fence post and gate frame pipe.
- Top Rail End Goes Between the Brace Bands and the Top Rail Holding the Chain Link Top Rail in Place
- Rail End is Black Powder Coated to Prevent Red Rust.
- Used for many chain link fence applications where 1-3/8" or 1-5/8" Black Chain Link fence pipe is used.
- Rail Ends can Also be Used to Put a Pipe Along the Bottom of a Fence
- **Not All Top Rail or Fence Pipe is The Same. Please Measure Yours Prior to Ordering**



# CHAIN LINK FENCE HARDWARE



## Chain Link Fence Post - Loop Cap (Eye Top)

### SIZES

**Aluminum 1-5/8" x 1-3/8"**

**Aluminum 1-7/8" x 1-5/8"**

**Aluminum 1-7/8" x 1-3/8"**

**Aluminum 2-3/8" x 1-5/8"**

Discounts apply to any purchase of two (2) + of this product in course of the same order.

- Order 2 or More Chain Link Eye Top Loop Caps and Save 35%
- These Loop Caps fit Fence Posts With Outside Diameters of 1-5/8", 1-7/8" and 2-3/8"
- Holds Outside Diameter Top Rails from 1-3/8 to 1-5/8"
- Aluminum Chain Link Fence Eye Top Loop Cap Holds Rail in Place on Top of Line Post
- Eye Tops Will Give Your Chain Link Fence Post a Nice Finished Look.
- Keeps Water and Snow Out to Prevent Fence Post Internal Damage
- These Eye Top - Loop Caps are Made of Durable Aluminum to Prevent Red Rust.
- **Please Pre-Measure your fence posts and Top Rail to Ensure You Receive the Proper Sizes**

## Black Chain Link Fence Post - Loop Cap (Eye Top)

### SIZES

**1-5/8" x 1-3/8"**

**1-7/8" x 1-3/8"**

**1-7/8" x 1-5/8"**

Discounts apply to any purchase of two (2) + of this product in course of the same order.

- Order 2 or More Chain Link Rail Ends and Save 35%
- Loop Cap / Eye Top Protects and Finishes Chain Link Fence Posts, Securely Holds Top Rail in Place
- These Eye Tops are Quality Aluminum and are Painted in Black Enamel Paint to Prevent Rusting
- Eye Top Prevents Snow and Rain From Entering the Inside of Fence Post Lending to Longer Life of the Post.
- Order 7 or More Chain Link Rail Ends and Save 45%
- The Quality Finish of the Metal and Paint Will Give Your Fence a Smooth and Polished Look
- Loop Caps fit Fence Post with Outside Diameters of 1-5/8" and 1-7/8"
- Designed to Hold Top Rails with Outside Diameters of 1-3/8" and 1-5/8"
- **Please Pre-Measure your fence posts and Top Rail to Ensure You Receive the Proper Size**

## Galvanized Pressed Steel Fence Post Loop Cap

### SIZES

**1-5/8" x 1-5/8"**

**1-7/8" x 1-5/8"**

**2-7/8" x 1-5/8"**

**1-7/8" x 1-3/8"**

**2-3/8" x 1-5/8"**

**4" x 1-5/8"**

Discounts apply to any purchase of two (2) + of this product in course of the same order.

- Chain Link Fence Eye Tops - Loop Caps Holds Top Rail in Place on Top of Line Post
- Will hold Top Rails with Outside Diameters of 1-3/8" and 1-5/8"
- Eye Tops Will Give Your Chain Link Fence Post a Finished Look.
- Keeps the Weather Out to Prevent Fence Post Internal Damage
- Eye Top - Loop Caps are Made of Galvanized Pressed Steel to Prevent Red Rust.
- **Please Pre-Measure Your Fence Posts and Top Rails to Ensure You Receive the Proper Size**



# CHAIN LINK FENCE HARDWARE

## BLACK - Aluminum Chain Link Fence Post Cap

### SIZES

1-3/8"	1-5/8"	1-7/8"
2-3/8"	2-7/8"	3-1/2"
		4"

Discounts apply to any purchase of two (2) + of this product in course of the same order.

• Order 2 or More Chain Link Post Caps - BLACK and Save 35% • Order 7 or More Chain Link Post Caps - BLACK and Save 45%

- Chain Link Fence Post Caps for Pipes or Posts With "Outside Diameters" from 1-3/8" to 4"
- Chain Link Fence Post Cap is Black Powder Coated Aluminum for Years of Life Expectancy.
- Gives Your Chain Link Fence Post a Finished Look and Keeps the Weather Out for Longer Fence Life
- This Size Cap is Used on Many Chain Link Posts, Kennels, Gates and Fence Panels.
- These Post Caps Fit Over Pipe or Post and Are Not Meant for Interior Pipe Installation
- **Please Measure Chain Link Post Outside Diameter to Select Proper Fence Post Cap Before Ordering**



## Aluminum and Steel Chain Link Post Cap

### SIZES

1-3/8"	1-5/8"	1-7/8"
2-3/8"	2-7/8"	3-1/2"
4"	4-1/2"	6-5/8"

Discounts apply to any purchase of two (2) + of this product in course of the same order.

• Order 2 or More Chain Link Post Caps and Save 35% • Order 7 or More Chain Link Post Caps and Save 45%

- For applications where 1-3/8" to 6-5/8" Outside Diameter pipe is used
- Chain Link Post Caps fit Over the Outside of Pipe or Post, not Made For Interior Installation
- Gives Your Chain Link Fence Post a Finished Look and Keeps the Weather Out for Longer Post Life
- Used in Many Chain Link Fence Applications Including Gates, Dog Kennel Panels, or Gate Panels.
- The 1-3/8" Through 4" Post Caps Are Made From Aluminum
- The 4-1/2" and 6-5/8" Post Caps Are Manufactured From Galvanized Steel
- **Please Pre-Measure Your Pipe or Post Prior to Ordering**



# CHAIN LINK FENCE HARDWARE



## Galvanized Chain Link Tension Bands

SIZES		
1-3/8"	1-5/8"	1-7/8"
2-3/8"	2-7/8"	3-1/2"
4"	Single / 12 / 30 Pack	6-5/8"

Discounts apply to any purchase of two (2) + of this product in course of the same order.

- Order 2 or More Chain Link Tension Bands and Save 35%      • Order 7 or More Chain Link Tension Bands and Save 45%
- This listing is for the 1-3/8" to 6-5/8" tension bands that fit the "Outside Diameter" of pipe and fence posts
- These chain link tension bands are manufactured from galvanized steel to resist rust
- Use to attach chain link fabric or mesh to a terminal, corner fence, end fence or gate fence post and gate frame pipe
- Tension bands wrap around the outside of the pipe on the fence and attach to a tension bar holding the fencing
- These tension bands are used for many chain link fence applications including fence gates, dog kennel panel pipe, fence and gate panels.
- As a "Rule of Thumb" use one less tension band per stretch than the height of the fence (Example: 4' Height Chain Link Fence use (3) Tension Bands)
- Measure the pipe or post prior to ordering to assure you receive the correct size

## Black Powder Coated Chain Link Tension Bands

SIZES		
1-3/8"	1-5/8"	1-7/8"
2-3/8"	2-7/8"	4"

Single / 12 / 30 Pack

Discounts apply to any purchase of two (2) + of this product in course of the same order.

- Order 2 or More Chain Link Tension Bands and Save 35%      • Order 7 or More Chain Link Tension Bands and Save 45%
- Chain Link Fence Tension Band fit Outside Diameter Pipes or Posts from 1-3/8" to 4"
- Tension Bands are Black Powder Coated to Prevent Red Rust.
- Tension Bands are Used for Attaching the Chain Link Mesh to an Corner, End, Gate Post or Gate Frame
- Tension Bands Wrap Around the Pipe on the Fence and Attach to a Tension Bar Holding the Fencing
- Choose your Chain Link Fence Tension Bands Based on the Outside Diameter of your Chain Link Fence Post
- As a Rule of Thumb Use One Less Tension Band per Stretch than the Height of the Fence (Example: 4' Height Chain Link Fence use (3) Tension Bands)
- Measure the pipe or post prior to ordering to assure you receive the correct size

# CHAIN LINK FENCE HARDWARE

## Galvanized Chain Link Brace Bands

### SIZES

1-3/8"	1-5/8"	1-7/8"
2-3/8"	2-7/8"	3-1/2"
4"		6-5/8"

Discounts apply to any purchase of two (2) + of this product in course of the same order.

- Order 2 or More Chain Link Brace Bands and Save 35%    • Order 7 or More Chain Link Brace Bands and Save 45%
- Chain Link Fence Brace Bands for Outside Diameter Pipes and Posts From 1-3/8" to 6-5/8"
- Brace Bands are Manufactured From Galvanized Steel for Long Life and to Prevent Rust
- Brace Bands are Used for Attaching the Chain Link Top Rail to a Corner, End or Gate Post
- Brace Bands Wrap Around the Pipe on the Fence and Attach to a Rail End Holding the Fence Top Rail
- Please measure the "Outside Diameter" of your pipe before purchase. Not all pipes are the same measure



## Black Powder Coated Chain Link Brace Bands

### SIZES

1-3/8"	1-5/8"	1-7/8"
2-3/8"	2-7/8"	4"

Discounts apply to any purchase of two (2) + of this product in course of the same order.

- Order 2 or More Chain Link Tension Bands and Save 35%    • Order 7 or More Chain Link Tension Bands and Save 45%
- Chain Link Fence Brace Bands Wrap Around a Chain Link Fence Post, Connects to the Top Rail End
- Brace Bands are Used for Attaching the Chain Link Top Rail End to a Corner, End or Gate Post
- Brace Band Can Also Be Used for Gates and Fence Panels.
- Brace Band is Black Powder Coated Steel to Prevent Red Rust.
- Choose your Brace Bands Based on the "Outside Diameter" of Your Chain Link Fence Post
- Please measure the "Outside Diameter" of your pipe before purchase. Not all pipes are the same measure



## HAVE QUESTIONS? NEED ANSWERS?

E-mail: [tom@jakesales.com](mailto:tom@jakesales.com)  
 Phone: (406) 752-5253  
 Website: [jakesales.com](http://jakesales.com)

# Jake Sales

[www.jakesales.com](http://www.jakesales.com)



# CHAIN LINK FENCE HARDWARE



## Chain Link Fence Gate Clip

SIZES	QTY
1-3/8"	Single Pack or 20 Pack

Discounts apply to any purchase of two (2) + of this product in course of the same order.

• Order 2 or More Chain Link Fence Gate Clip 1-3/8" Save 10%

- Gate Clip AKA Kennel Panel Clips (bands or straps) are for 1-3/8" "outside diameter" measured pipe.
- Gate clips are made from galvanized steel to prevent rusting
- Used to stretch chain link fabric on gate, chain link fence panels, or chain link kennels.
- Connect to gate with gate clip and tension bar or chain link gate rod.
- Use one gate clip per foot of gate height (minus one)  
*Example: if your gate is 4' tall, use 3 clips on each vertical gate frame pipe*
- Can be used for dog kennels, dog runs, chicken coops and more.

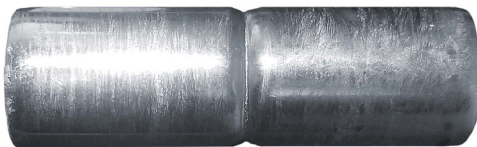

## 6" Chain Link Fence Top Rail Sleeve

SIZES	QTY
1-3/8"	Single Pack, 2 Pack or 8 Pack
1-5/8"	
1-7/8"	

- Use to connect chain link fence top rail for fence or dog runs, kennels, shelters and more.
- Chain link fence top rail slides inside of this sleeve to connect 2 pieces of top rail.
- This Top Rail Sleeve can also be called a chain link fence Top Rail Connector or Top Rail Adapter.
- This Top Rail Pipe Sleeve is Galvanized to last as long as the rest of the chain link fence.
- Use for "outside diameter" pipes sizes 1-3/8", 1-5/8" and 1-7/8"
- **Please measure your top rail prior to ordering - not all rails are of the same measure.**

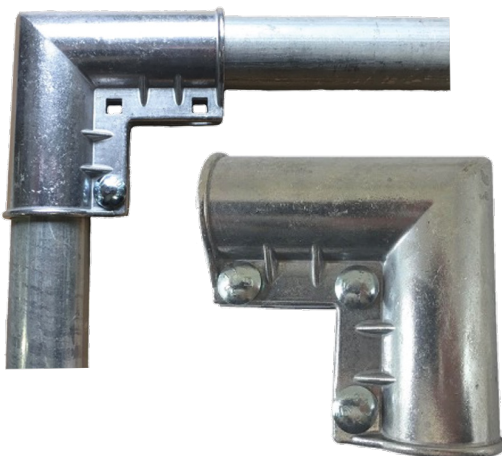

## 1-3/8" Residential Chain Link Fence Gate Corner

Discounts apply to any purchase of two (2) + of this product in course of the same order.

• Order 2 or More Fence Gate Corner Save 10%

• Order 6 or More Fence Gate Corners Save 20%

- Chain Link Fence Gate Corners for building or replacing a chain link gate using 1-3/8" gate frames
- Gate corners are made of aluminum, will not rust.
- When building a gate use 4 of these chain link gate corners per gate.
- No welding is required when building a gate using this product
- 1-3/8" gate frames are the most popular choice for residential chain link fence gate construction.
- Corners includes bolts for installation.

# CHAIN LINK FENCE HARDWARE

## Galvanized Carriage Bolts (w/nuts) – Qty 100

### SIZES

5/16" x 1-1/4"	3/8" x 2-1/4"
5/16" x 2"	3/8" x 2-1/2"
5/16" x 2-1/2"	3/8" x 3"
3/8" x 2"	3/8" x 3-1/2"

- 3/8-16 x 3-1/2": w/ NUTS Galvanized Bulk Carriage Bolt ~ Coarse Thread (3 1/2 in)
- The thread pitch on these bolts is 16 (3/8-16) an everyday use 3/8" coarse thread carriage bolt.
- The 3/8" galvanized NUTS are INCLUDED. Galvanized coating gives protection from corrosion.

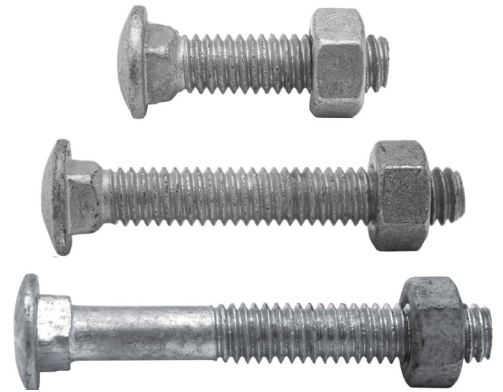

## Chain Link Fence Panel - Kennel Clamp

### SIZES

### QTY

1-3/8"	Single Pack or 8 Pack
1-5/8"	
1-7/8"	

Discounts apply to any purchase of two (2) + of this product in course of the same order.

- Order 8 or More Chain Link Panel Clamps and Save 60%
- **1 PACK** of Dog kennel panel clamps If you are setting up temporary fencing with chain link panels or other pipe panels that have 1-3/8" pipe frames
- These panel clamps are also used as "Kennel clamps" for building a chain link dog kennel (or chain link dog run)
- Panel clamps are used to secure to pieces of rail parallel to one another
- They are frequently used to bolt two kennel panels together, two per panel.
- Also used on "baseball backstops" to secure the overhead canopies.
- There are many known applications that they can be used for, they are sturdy and easy to use.



For SAFETY Install NUT to OUTSIDE of Kennel



INSIDE KENNEL



OUTSIDE KENNEL

## T-Clamp (for "T"-ing into a pipe)

### SIZES

### QTY

1-3/8"	Single Pack
--------	-------------

Discounts apply to any purchase of two (2) + of this product in course of the same order.

- Order 4 or More Chain Link T-Clamp and Save 45%
- This T-clamp allows you to "T"-ing into a piece of 1-3/8" chain link fence pipe with another 1-3/8" pipe.
- Use for making extensions to an existing fence, connecting chain link fence panels, and more
- Order 10 or More Chain Link T-Clamp and Save 60%
- These end clamps are galvanized for long term exterior use.
- T clamps are easy to install. Depending on what you are making you might want to purchase these in pairs (one for each pipe end).



# CHAIN LINK FENCE HARDWARE



## Wire Ties (Aluminum - Galvanized or Black)

SIZES	QTY
6-1/2"	30 Pack,
8-1/4"	100 Pack
10-1/2" (Galvanized Only)	or 300 Pack

Discounts apply to any purchase of two (2) + of this product in course of the same order.

• Order 2 or More Chain Link Fence Wire Hook Ties and Save 30%

• Order 7 or More Chain Link Fence Wire Hook Ties and Save 50%



- These are used to connect the chain link fence "mesh" wire to the top rail and to the posts
- These 8-1/4" wire ties can be installed on fence posts or rails up to 2-1/2" in diameter.
- These Wire Ties are heavy duty, 9 gauge wire
- Easy to install, just use one every 1 foot on the fence post (so 3 on a 4' post).
- And do 1 about every 18" on the chain link fence top rail.

## Chain Link Butterfly Latch - Qty 1

SIZES	
1-3/8" x 1-7/8"	1-3/8" x 2-3/8"
1-3/8" x 2"	1-3/8" x 2-1/2"

Discounts apply to any purchase of two (2) + of this product in course of the same order.

• Order 2 or More Chain Link Butterfly Latch and Save 10%

• Order 6 or More Chain Link Butterfly Latch and Save 20%

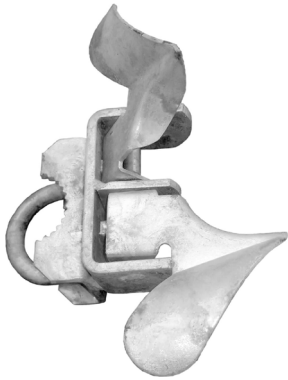

- Chain Link Fence "Post" Mount Style Butterfly Latch
- Fork Size fits gate posts with "outside diameters" from 1-7/8" to 2-3/8" (2-1/2")
- The latch attaches to gate frames with "outside diameter" measurement of 1-3/8"
- There should be a 2-5/16" gap between gate post and gate frame for best operation [see example]
- This Chain Link Gate Latch is a galvanized coated steel to prevent rust
- Easy to install, "U" bolt included with gate latch
- Latch can be padlocked for security
- Measure both gate post and gate frame prior to ordering to assure you receive the correct item

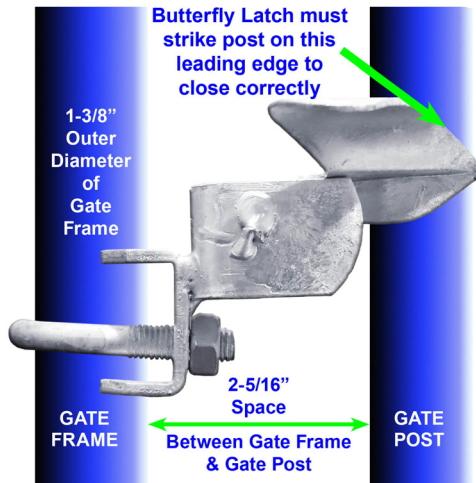

ALL orders shipping in the United States ship for

# FREE

Paid orders received before 12 noon, ship the same business day.





# CHAIN LINK FENCE HARDWARE



## Residential Chain Link Gate Fork Latch - Qty 1

### SIZES

1-3/8" x 1-3/8"	1-5/8" x 1-3/8"	1-7/8" x 1-3/8"
1-3/8" x 1-5/8"	1-5/8" x 1-5/8"	1-7/8" x 1-5/8"
1-3/8" x 1-7/8"	1-5/8" x 1-7/8"	1-7/8" x 1-7/8"
1-3/8" x 2-3/8"	1-5/8" x 2-3/8"	1-7/8" x 2-3/8"
1-3/8" x 2-7/8"	1-5/8" x 2-7/8"	1-7/8" x 2-7/8"
1-3/8" x 4"	1-5/8" x 4"	1-7/8" x 4"

Discounts apply to any purchase of two (2) + of this product in course of the same order.

• Order 2 or More Chain Link Fork Latch and Save 10%

• Order 6 or More Chain Link Fork Latch and Save 20%

- Chain Link Gate Fork Latch comes in various gate frame and fence post sizes
- This latch will bolt to gate frames from 1-3/8" to 1-7/8" measured by "outside diameter" of gate frame
- Fork sizes will fit around gate posts from 1-3/8" to 4" measured by "outside diameter" of gate post
- It is important to measure both gate frame and gate post prior to ordering to ensure you order correct product
- Chain Link Gate Latch is manufactured from galvanized steel to prevent rusting
- Easy to install nuts and bolt are included
- This residential gate fork latch has a pre-drilled hole for installing a padlock.
- This residential latch was manufactured of durable material, designed to last for years

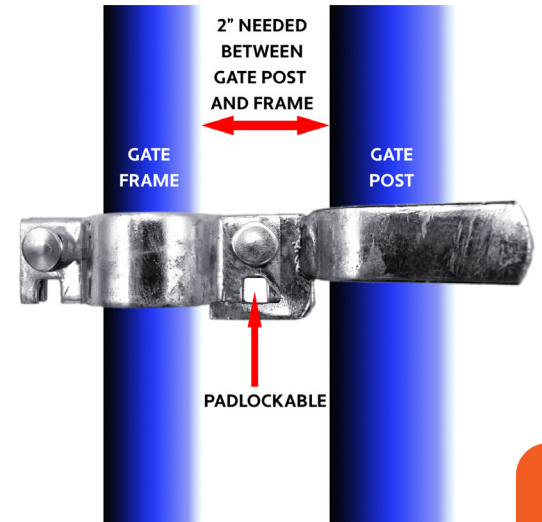

## Flat Back Wall Mount Fork Gate Latch - Qty 1

### SIZES

1-3/8"	1-5/8"	1-7/8"
2-3/8"	2-7/8"	

Discounts apply to any purchase of two (2) + of this product in course of the same order.

• Order 2 or More Chain Link Fence Wall Mount (flat back) Fork Latch and Save 10%

• Order 6 or More Chain Link Fence Wall Mount (flat back) Fork Latch and Save 20%

- Chain Link Gate latch easily mounts on a wall, wood post, or other flat vertical surfaces
- Fork size fits chain link fence post frames from 1-3/8" to 3"
- Use in place of a latch post against a house or shop etc where conditions are unsuitable for a post
- Product is made from galvanized steel to prevent rusting
- Latch holds gate secure and can be padlocked for security
- Please measure "outside diameter" of latch post prior to order to ensure you order correct product**



# CHAIN LINK FENCE HARDWARE



In most cases, the handle must be **54" ABOVE** the bottom of the gate.



## Chain Link Child Safety Pool Latch - Push Style

### POOL LATCH POST SIZE\*:

1-3/8" Gate Frame; 1-7/8" Gate Post

1-3/8" Gate Frame; 2-3/8" Gate Post

1-5/8" Gate Frame; 2-3/8" Gate Post

Discounts apply to any purchase of two (2) + of this product in course of the same order.

- Order 2 or more Pool Latch - Child Proof Gate Latch - **Save 15%**
- This Auto Pool Latch swings in or out and is pad-lockable from both sides.
- Pool latch constructed from strong, high impact plastic
- Capable of horizontal and vertical adjustment
- Reversible (right or left handed) with easy grip release knob
- Fits "outside diameter" 1-3/8" or 1-5/8" gate frames
- The fork latch fits around "outside diameter" gate posts from 1-7/8" to 2-3/8" (2-1/2")
- Auto Pool Latch comes in 3 configurations:
  - 1-3/8" X 1-7/8"
  - 1-3/8" X 2-3/8" (2-1/2")
  - 1-5/8" X 2-3/8" (2-1/2")
- Easy to install, even on existing gates, Will allow gate to swing both ways
- Self-latching with spring hinges, you will need a Gate Spring Closer to self-close (purchased separately)
- **Please measure both gate frame and gate post before ordering to ensure you receive correct product.**

*Complies with Most Pool Codes, Check Your Local Ordinance Before Ordering. Regulations Vary From Area to Area*

## Chain Link Strong Arm Gate Latch - Single

### SIZES

2-1/2"	3"	4"
--------	----	----

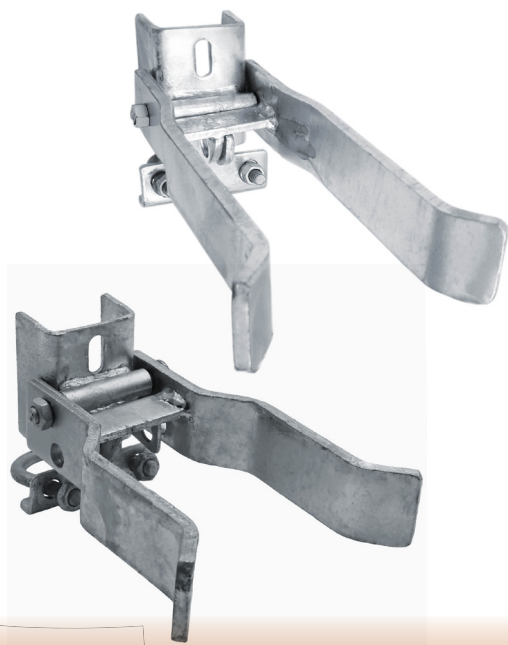

- Strong Arm Sentry Style Commercial Grade Fulcrum Single Gate Latch is quality made.
- This Fulcrum fork latch fits around "outside diameter" 2-1/2", 3" and 4" fence posts.
- Latch will clamp to "outside diameter" gate frames 1-5/8" thru 2".
- 3" and 4" Latches can be padlocked for better security (2-1/2" cannot be padlocked)
- Manufactured from hot dip galvanized steel to prevent rusting
- This Chain Link Single Gate Latch installs easily with the included installation hardware
- **Please measure both gate frame and fence post prior to ordering to ensure proper fit**

# CHAIN LINK FENCE HARDWARE

## HD Chain Link Gate Malleable Fork Latch

### SIZES

1-3/8" x 1-7/8"		1-3/8" x 2-3/8"	
1-5/8" x 2-3/8"	1-5/8" x 2-7/8"	1-5/8" x 4"	
1-7/8" x 2-7/8"		1-7/8" x 4"	

Discounts apply to any purchase of two (2) + of this product in course of the same order.

- Order 2 or More Heavy Duty Chain Link Gate Malleable Fork Latch and Save 10%
- Heavy Duty Commercial Gate Latch, fork sizes will fit gate post with "outside diameters" from 1-7/8" to 4"
- Latch will clamp to "outside diameter" 1-3/8", 1-5/8" or 1-7/8" gate frames
- Made of a galvanized steel and hardened surface for rust resistance
- These latches are made for commercial chain link fence gates and are designed for durability
- Order 6 or More Heavy Duty Chain Link Gate Malleable Fork Latch and Save 20%
- This commercial gate latch provides an easy 90 degree movement when manually opening and closing a gate.
- Gate Fork Latch can be padlocked to provide security
- Easy to install only one bolt to tighten on latch
- **Please measure both gate post and gate frame prior to ordering to ensure proper fit**



## Chain Link Single Gate Fulcrum Latch

### SIZES

1-5/8" (1-7/8") x 2-1/2"	1-5/8" (1-7/8") x 3"
--------------------------	----------------------

Discounts apply to any purchase of two (2) + of this product in course of the same order.

- Order 2 or More Chain Link Fulcrum Single Gate Latches and Save 10%
- Single Gate Latch is Made of Hot Dip Galvanized Steel to Prevent Rusting
- This Chain Link Gate Latch Fork Latches to "Outside Diameter" 2-1/2 or 3" Inch Fence Post.
- Both Gate Latches fit "Outside Diameter" Gate Frames 1-5/8 Inches thru 1-7/8 Inches.
- Can be Bolted to Either a Square or Round Gate Frame
- Can be Padlocked from both sides for Security
- This Chain Link Single Gate Latch Installs Simply with the Included Latch Installation Hardware
- Bolts and Nuts are Included
- Order 6 or More Chain Link Fulcrum Single Gate Latches and Save 20%
- **Please Measure Both Fence Post and Gate Frame Prior to Ordering to Ensure Product Will Fit**

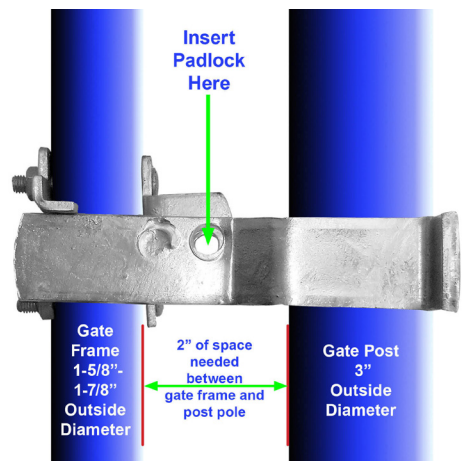



# CHAIN LINK FENCE HARDWARE

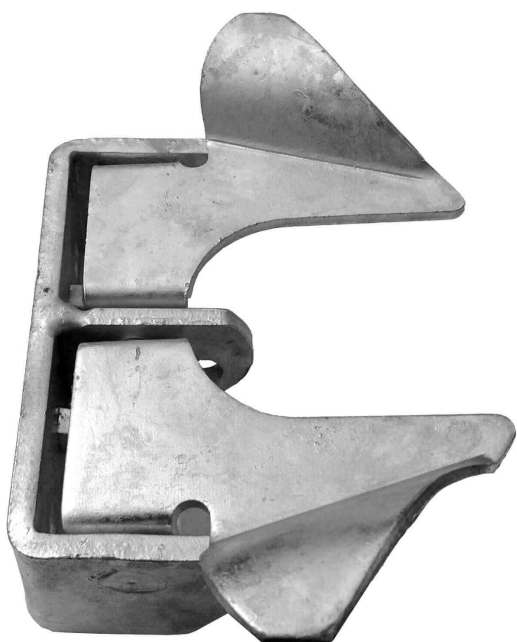

## Wall Mount Gate Butterfly Fork Latch

### Single

Discounts apply to any purchase of two (2) + of this product in course of the same order.

• Order 2 or More Wall Mount Butterfly Gate Latch and Save 10% • Order 6 or More Wall Mount Butterfly Gate Latch and Save 20%

- Butterfly Gate Latch fits around “outside diameter” 1-3/8” - 1-5/8” gate frames.
- Great Latch for places where a latch post can not easily be installed.
- **Mount Butterfly Latch needs 2” of space between the gate frame and the wall or wood post for the latch to operate easily.**
- Wall or Wood Post Mounted Butterfly Fork latch flips up on both sides. Gate can be latched both ways
- Latch made of galvanized steel to prevent rusting.
- Wall or Wood Post Mount Butterfly Latch is easy to install with 2 lag bolts or heavy duty screws.
- **Please measure your gate frame prior to ordering to ensure you product will fit correctly**

## Chain Link Dog Kennel Gate Latch

### Single

Discounts apply to any purchase of two (2) + of this product in course of the same order.

• Order 2 or More Chain Link Dog Kennel Gate Latch and Save 10% • Order 6 or More Chain Link Dog Kennel Gate Latch and Save 20%

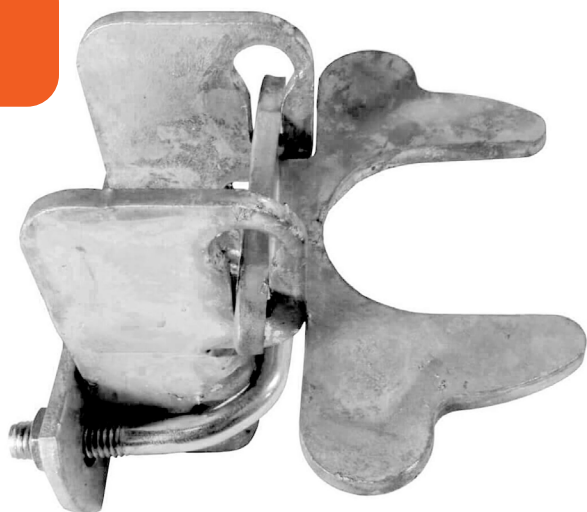

- This latch can be used for any fence that has a 1-3/8” gate frame and 1-3/8” panel frame
- Great kennel latch for dog kennels, dog runs, or any other chain link pen type enclosure.
- Latch design resists accidental opening of gate, safely and securely keep pets in or out of an area.
- Chain link dog kennel latches provide a tighter gap between the kennel gate frame and panel
- Dog kennel latch includes 5/16” carriage bolt use with 1-3/8” gate post and gate frame
- Our dog kennel latches are made of galvanized steel and is easy to operate.
- Spacing between kennel gate and panel should be approximately 1 inch.
- Kennel latch is easy to install with a standard 1/2” socket or wrench.



# CHAIN LINK FENCE HARDWARE

## Rolling Chain Link Fence Gate Offset Latch

### ROLLING OFFSET LATCH - "LOCK N' LATCH"

#### (Rolling or Cantilevered Gate Latch) - Single

Discounts apply to any purchase of two (2) + of this product in course of the same order.

• Order 2 or More Rolling Chain Link Fence Gate Offset Latch and Save 10%

• Order 6 or More Rolling Chain Link Fence Gate Offset Latch and Save 20%

- 1-5/8" to 1-7/8" Lock N' Latch to close a Rolling, Sliding, or a Cantilevered Chain Link Fence Gate
- Fits the 1-5/8" to 1-7/8" chain link gate frame pipe.
- This particular Lock N' Latch style latch is OFFSET to the side as opposed to straight on like some.
- Use chain link fence brace bands (sold separately)\*\* to connect to latch post

- A great latch for chain link fence gates, can be used as a wood gc latch if it is used with a pipe to close to.

- This rolling gate offset latch can be pad locked for security
- Galvanized steel to prevent rustin

**\*\* Brace bands are measured by "outside diameter" of the latch post. Please measure the post prior to ordering \*\***

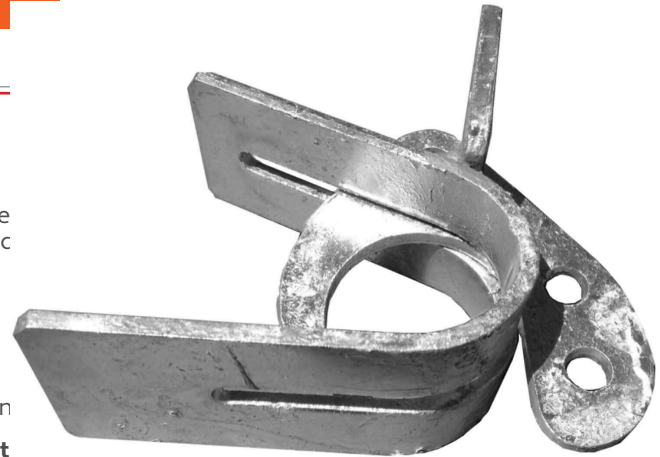

## ROLO Chain Link Gate Latch

### For 1-5/8" & 1-7/8" (2") Chain Link Gate Pipe Sizes

Discounts apply to any purchase of two (2) + of this product in course of the same order.

• Order 2 or More Rolo Chain Link Fence Gate Latch (Rolling Gate Latch) and Save 10%

• Order 6 or More Rolo Chain Link Fence Gate Latch (Rolling Gate Latch) and Save 20%

- Use with chain link fence rolling gates, sliding gates or cantilevered rolling gates.
- "ROLO" rolling gate latch works with "outside diameter" 1-5/8" & 1-7/8" (2") chain link gate frames
- This ROLO rolling chain link gate latch can be pad-locked for security.

- Drop pin into place once gate is shut.
- Attaches to chain link fence post (latch post) with 2 Brace Bands (sold separately)\*

**\* Brace bands are measured by "outside diameter" of post.**

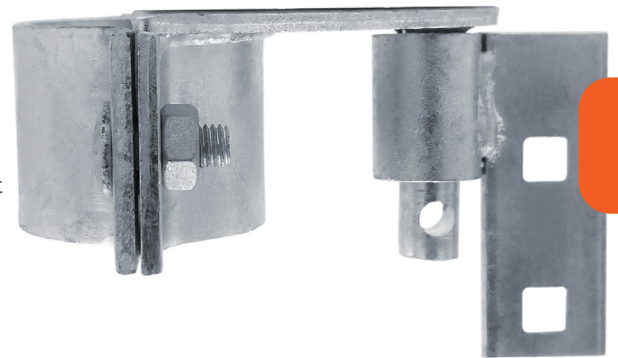

## Chain Link Fence Gate Hold Back

### (1-3/8" - 2-3/8")

Discounts apply to any purchase of two (2) + of this product in course of the same order.

• Order 2 or More Duckbill Gate Holdback and Save 10%

• Order 6 or More Duckbill Gate Holdback and Save 20%

- "Duck Bill" Gate Holdback keeps your gate open for you eliminating need to hold it.
- Simply install a 1-3/8" - 2-3/8" outside diameter post in the best position for the gate and fasten the "Duck Bill" hold back to that.
- If you are using 180 degree hinges you can install the holdback on the fence itself eliminating the separate post
- Releasing the gate is easy, just trip the holdback with your toe



# CHAIN LINK FENCE HARDWARE

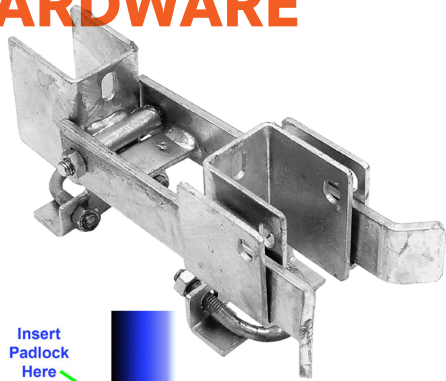

## Residential Strong Arm Double Gate Fulcrum Latch

For 1-5/8" thru 2" Gate Frames

Single

Discounts apply to any purchase of two (2) + of this product in course of the same order.

- Order 2 or More Residential Strong Arm Double Gate Fulcrum Latch and Save 10%
- Order 6 or More Residential Strong Arm Double Gate Fulcrum Latch and Save 20%
- Strong Arm Sentry residential double gate latch is made of hot dip galvanized steel
- Our heavy duty double gate strong arm gate latch quickly & securely latches two gates together, has 2 padlock locations
- Designed for "outside diameter" gate frames of 1-3/8"
- Includes all hardware necessary for installation
- No drop rod is needed when using this latch, product will hold gates firmly
- Allow for a 2" to 4" gap between chain link gates for proper operation
- Please be sure to measure gate frame to ensure product is correct for application

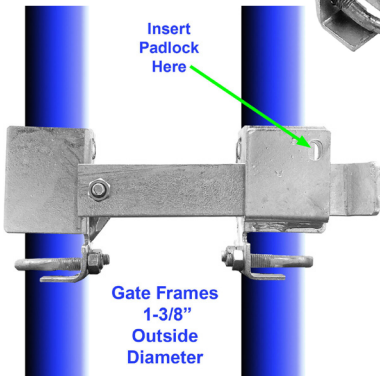

## Commercial Strong Arm Double Gate Fulcrum Latch

For 1-5/8" thru 2" Gate Frames

Single

Discounts apply to any purchase of two (2) + of this product in course of the same order.

- Order 2 or More Commercial Strong Arm Double Gate Latch and Save 10%
- Order 6 or More Commercial Strong Arm Double Gate Latch and Save 20%
- Strong arm sentry commercial grade double gate latch is made of hot dip galvanized steel
- This commercial grade, heavy duty gate latch quickly & securely latches two gates together. Latch has 2 PadLock Locations
- Latch is designed for gate frames with "outside diameter" frames of 1-5/8" thru 2".
- Installs simply with the included latch installation hardware
- No Drop Rod Needed, product is sturdy enough to hold gates firmly when using using included carriage bolts
- Please measure gate frame diameter prior to ordering to ensure product will fit properly

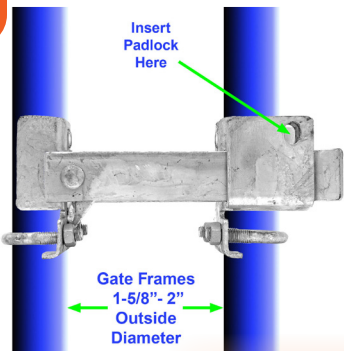
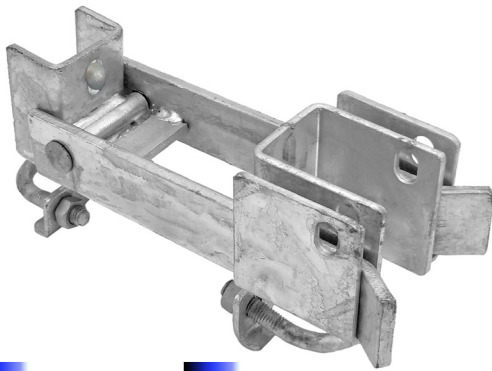

### Easy Process

Purchasing the product and shipping was easy. Could not find this product locally, just Googled what I wanted and Jake Sales was the first site that showed up. Easy to use and quick. Really appreciated the great customer service as well.

~ S. Ross, Honolulu, HI- Online Reviewer





# CHAIN LINK FENCE HARDWARE

## Chain Link Gate Cane Bolt

(Single or Double Gate) - 1-3/8" X 36"

### Single

Discounts apply to any purchase of two (2) + of this product in course of the same order.

- Order 2 or More Chain Link Gate Cane Bolt and Save 10%
- Order 6 or More Chain Link Gate Cane Bolt and Save 20%

- Drop Rod AKA Cane Bolt or Drop Pin for Chain Link Fence Single or Double Chain Link for 1-3/8" Gate Frames
  - Galvanized, Secures Your Chain Link Gate Firmly as it Utilizes a Center Stop in the Ground
  - Includes the necessary 2 Gate Clamps to fit a typical 1-3/8" Chain Link Fence Gate Frames
- Be sure to measure your gate frame prior to ordering to ensure you receive the correct product**

## Chain Link Gate Drop Rod

(Double Gate) - 1-3/8" x 36"

### Single

Discounts apply to any purchase of two (2) + of this product in course of the same order.

- Order 2 or More Chain Link Gate Drop Rod and Save 10%
- Order 6 or More Chain Link Gate Drop Rod and Save 20%

- Also called a chain link gate cane bolt or drop pin, used to help latch and secure a double chain link gate
  - The 2 brackets will connect to one gate, while the top part, the latch, will hold the other gate.
  - Drop rod is 36" long and includes the required clamps to attach to a 1-3/8" gate frame
  - Has set screw to allow you to raise and pivot drop pin to a resting position
  - When opening and closing gate the drop pin will not drag on the ground, the set screw rests on the bracket
  - When installing we recommend an approximate 2" space between gates
  - This gate drop rod can be padlocked for security
- Please measure your gate frame "outside diameter" to ensure product will fit before ordering**

## Commercial Chain Link Gate "Bull Dog" Hinge

### SIZES

2-3/8"	4"
2-7/8"	6-5/8"

Discounts apply to any purchase of two (2) + of this product in course of the same order.

- Order 2 or More Chain Link Gate Bull Dog Hinges and Save 10%
- Order 10 or More Chain Link Gate Bull Dog Hinges and Save 15%
- Chain Link Fence Gate Post Hinge for 2-3/8" Outside Diameter Pipe/Post
- Can Be Used For Either 1-5/8" or 1-7/8" Gate Frames
- Gate Hinge is Made of Galvanized Steel to Prevent Red Rust
- Commercial Heavy Duty Grade Hinge Pivots 95 Degrees for Easy Access Through Fence Gate
- Gate Hinge Nuts/Bolts are included With This Commercial Grade Heavy Duty Fence Gate Hinge.



# CHAIN LINK FENCE HARDWARE

## 180 Degree Gate Hinge Assembly

### SIZES

2-3/8"	4"
2-7/8"	6-5/8"

Discounts apply to any purchase of two (2) + of this product in course of the same order.

- Order 2 or More Chain Link Gate 180 Degree Gate Hinge and Save 10%
- Order 10 or More Chain Link Gate 180 Degree Gate Hinge and Save 15%

- For Chain Link Fence Gate, Industrial Offset Pressed Steel Hinge, Industrial Offset Hinge
- Gate Hinge is made of galvanized steel to prevent red rust
- A 180 degree hinge swings the chain link gate up against the chain link fence to keep it out of the way
- All hinges fit either a "outside diameter" 1-5/8" or 1-7/8" chain link gate frame
- Will attach to "outside diameter" fence post sizes from 2-3/8" to 6-5/8"
- Number of 180 Degree hinges needed per chain link gate: two (2)
- "U" Bolts for gate hinge are included
- **Please measure both your gate frame and fence post prior to ordering to ensure correct product fit**

*A Gate Holdback (Duckbill) is great for holding a gate open when using 180 degree hinges*

## Chain Link Fence Gate Frame Hinge

### SIZES

1-3/8"	1-5/8"
1-7/8"	

Discounts apply to any purchase of two (2) + of this product in course of the same order.

- Order 2 or More Chain Link Gate Frame Hinges and Save 10%
- Order 10 or More Chain Link Gate Frame Hinges and Save 15%

- Chain Link Fence Gate Frame Hinge, Female Frame Gate Hinge with 5/8" Pin Hole
- Chain Link Fence Frame Hinge is galvanized steel for years of life expectancy.
- Gate Post Hinge is designed for smooth gate operation
- Will fit gate frame sizes from 1-3/8", 1-5/8", or 1-7/8" measured by "outside diameter" of gate frame
- Use in conjunction with a Post Hinge, a Flat Back Wall Mount Hinge or a Lag Screw Hinge
- Includes gate frame hinge bolt for easier installation without a trip to the hardware store
- Use 2 chain link frame hinges per standard chain link single swing gate
- **Be sure to measure your gate frame prior to ordering to ensure your product will fit correctly**



# CHAIN LINK FENCE HARDWARE

## J-Bolt Threaded Bolt Style Gate Hinge

### SIZES

6"	8"
10"	12"

Discounts apply to any purchase of two (2) + of this product in course of the same order.

• Order 4 or More J-Bolt Threaded Bolt Style Gate Hinge 6" to 12" Save 25%

- Hinge has a 5/8" Gate Hinge Pin and Available in 4 sizes 6", 8", 10" and 12"
- J-Bolt Fence Post Hinges install easily: drill hole and slide J-bolt post hinge through hole with one nut on hinge then install second nut.
- J-Bolt thru post hinges are easy to adjust even after the gate is installed by loosening the nuts and turning nuts in or out for proper gate line up
- Gate Hinge is Made of Galvanized Steel to Prevent Red Rust.
- Gate Post Hinge is Designed for Years of Smooth Gate Operation. Nuts for Gate Hinge are Included

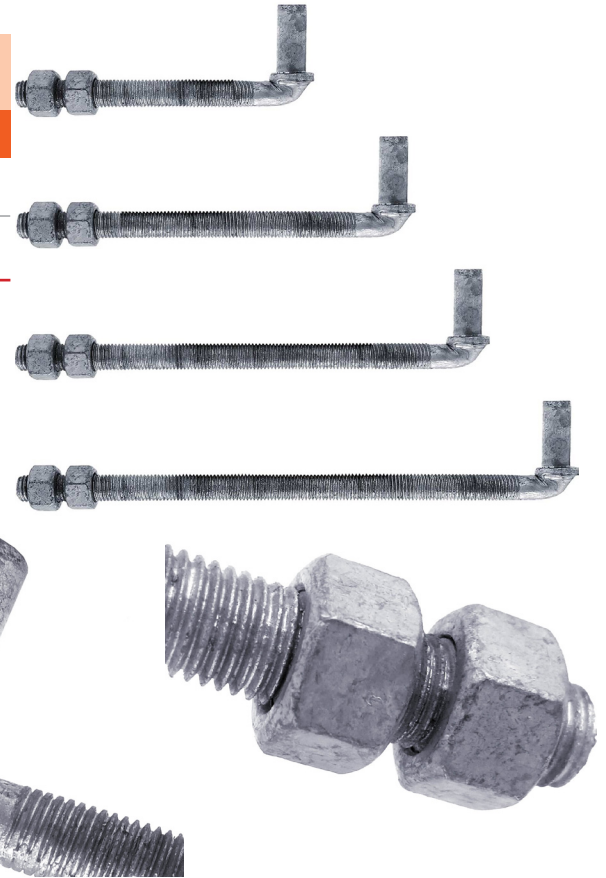

## Chain Link Fence Post Male Hinge w/Bolt

### SIZES

1-3/8"	1-5/8"
1-7/8"	2-3/8"
2-7/8"	

Discounts apply to any purchase of two (2) + of this product in course of the same order.

• Order 2 or More Chain Link Gate Post Hinges and Save 10%    • Order 10 or More Chain Link Gate Post Hinges and Save 15%

- Chain Link Fence Gate Post Hinge for "Outside Diameter" Pipe or Posts from 1-3/8" to 2-7/8"
- All hinges have a Male 5/8" Gate Pin
- Chain Link Fence Post Hinges are Galvanized Steel for Years of Life Expectancy
- These are the Most Common Sizes for Chain Link Gates
- Gate Post Hinge is Designed for Years of Smooth Gate Operation.
- Nut/Bolt for Gate Hinge Included
- Works in Conjunction with the Gate Frame Hinge





# CHAIN LINK FENCE HARDWARE

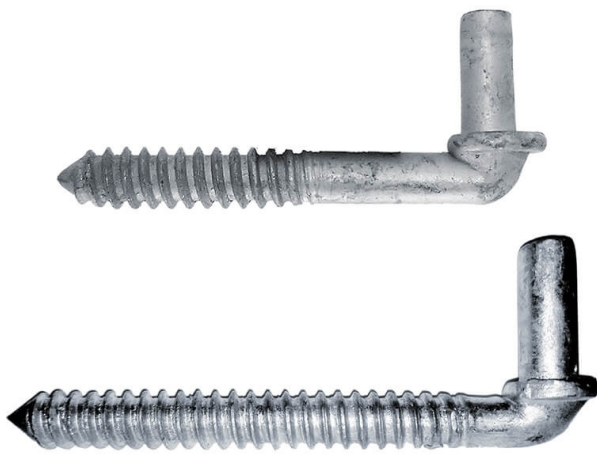

## Lag Screw Chain Link Gate Post Hinges

### SINGLE PACK - SIZES

4-1/2"

6"

Discounts apply to any purchase of two (2) + of this product in course of the same order.

• Order 2 or More Chain Link Gate Lag Screw Hinge and Save 10%

• Order 10 or More Chain Link Gate Lag Screw Hinge and Save 15%

- This lag screw hinge is excellent way to install chain link gate on a wood post
- Wood post lag screw hinge comes in either 4-1/2" or 6", also known as a lag bolt hinge
- Both hinges have a 5/8" diameter pin that is 1-1/2" in length
- Lag screw hinge is easy to install,

- simply drill a hole in the post and screw the hinge in.
- Hinge is manufactured from galvanized steel to prevent rust
- Typically you use 2 lag screw hinges per gate
- Works in conjunction with a **Gate Frame Hinge**

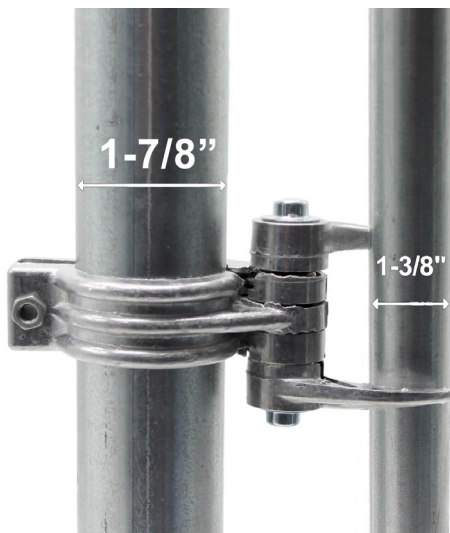

## Aluminum Chain Spring Type Gate Closer

### SINGLE PACK - SIZES

1-3/8" x 1-7/8" (2")

1-3/8" x 2-3/8" (2-1/2")

Discounts apply to any purchase of two (2) + of this product in course of the same order.

• Order 2 or More Chain Link Gate Frame Hinges and Save 10%

• Order 10 or More Chain Link Gate Frame Hinges and Save 15%

- Gate Closer comes in two (2) sizes 1-3/8" x 1-7/8" (2") Closer or a 1-3/8" x 2-3/8" (2-1/2") Closer - "outside diameters"
- Closer bolts to a either a 1-7/8" (2") OR a 2-3/8" (2-1/2") gate hinge post while the pincer arms fit around a 1-3/8" Gate Frame
- Durable, rust proof aluminum construction for low maintenance and long product endurance
- Internal springs close the gate when opened 90 Degrees in either direction automatically and securely
- You can use one closer for standard gates although we recommend you use two closers for better performance
- Combine with self-latching gate mechanism for peace of mind security (sold separately)

- The manufacturer does not recommend you force the gate open past 90 Degrees while using these closers
- Do not over-tighten bolt when installing, you will want to leave a slight gap in the clamp
- **Please measure your gate hinge post and gate frame prior to ordering to ensure your product will fit correctly**

**Please Check Your Local Regulations for Pool Gate Requirements. Regulations Vary From Area To Area.**

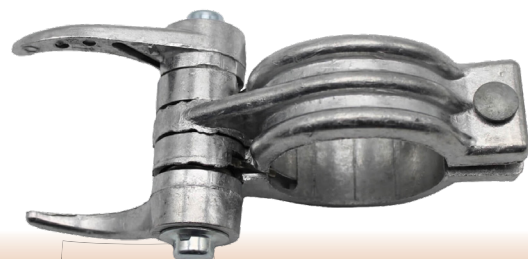

# CHAIN LINK FENCE HARDWARE

## Wood Post Flat Back Chain Link Fence Gate Hinge

### SINGLE PACK

Discounts apply to any purchase of two (2) + of this product in course of the same order.

- Order 2 or More Chain Link Gate Wall/Wood Post Mount Hinges and Save 10%
- Order 10 or More Chain Link Gate Wall/Wood Post Mount Hinges and Save 15%
- Flat Back Wood Post Mount hinge is for starting or ending your fence against a Wood Post or flat vertical surface.
- The 5/8" male pin will let you use in conjunction with a 5/8" female Frame Hinge.
- Takes 2 of these wall mount plate hinges for most gates.
- Screw or bolt to wood post or flat surface.
- Can be mounted to a barn, shed, flat wood fence, or any other upright flat surface.



## 5/8" Wall Mount Flat Back Chain Link Fence Gate Hinge

### SINGLE PACK

Discounts apply to any purchase of two (2) + of this product in course of the same order.

- Order 2 or More Chain Link Gate Wall/Wood Post Mount Hinges and Save 10%
- Order 10 or More Chain Link Gate Wall/Wood Post Mount Hinges and Save 15%
- Flat Back Wall Mount hinge is for starting or ending your fence against a flat vertical surface.
- Handy to mount your hinge to a barn, shed, flat wood fence, or any other upright flat surface.
- The 5/8" male pin will let you use in conjunction with a 5/8" female Frame Hinge.
- Galvanized Steel to prevent rust and promote longevity of product
- Takes 2 of these wall mount plate hinges for most gates.



## 1-3/8" Chain Link Kennel Gate Hinge

### SINGLE PACK

Discounts apply to any purchase of two (2) + of this product in course of the same order.

- Order 2 or More Chain Link Gate Wall/Wood Post Mount Hinges and Save 10%
- Order 10 or More Chain Link Gate Wall/Wood Post Mount Hinges and Save 15%
- Dog Kennel Hinge for 1-3/8" "outside diameter" pipe
- Inserts in bottom and top of 1-3/8 inch gate frame. No other chain link fence part needed.
- A strong and reliable hinge as this style of hinge incorporates the gate frame pipe into the hinge.
- This hinge slides up inside the chain link kennel gate frame
- Product is manufactured from galvanized steel to prevent rusting
- Great for dog kennels, dog runs, chicken coops and other applications
- Order 2 kennel gate hinges per gate. Includes bolt and nut
- Please measure the pipe you are mounting this hinge to prior to ordering to ensure product will fit correctly



# CHAIN LINK FENCE HARDWARE

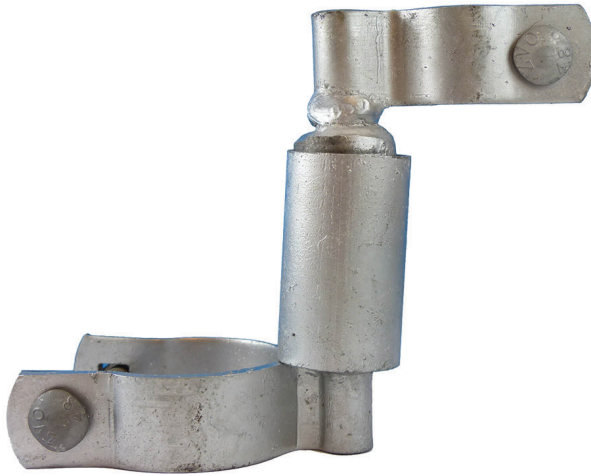

## Chain Link Gate Spring Closer

### SINGLE PACK

Discounts apply to any purchase of two (2) + of this product in course of the same order.

• Order 2 or More Chain Link Gate Spring Closers and Save 10%

• Order 10 or More Chain Link Gate Spring Closers and Save 15%

- Designed for use on 2-3/8" "outside diameter" gate posts and 1-3/8" "outside diameter" gate frames.
- Please measure both gate post and gate frame prior to ordering to ensure proper fit
- This spring closer allows the gate to open 90 degrees and has the necessary nuts and bolts for installation.
- The gap between your gate frame and gate post should be 2 Inches for the spring closer to work effectively.

• One Self Closer will work for Standard Chain Link Gate however Two (2) are Recommended for Best Results

• Chain Link Gate Closer Includes the Necessary Bolts/Nuts for Installation

**Please Check Your Local Regulations for Pool Gate Requirements. Regulations Vary From Area To Area. Thank you**



## Chain Link Fence Rolling Gate Track Bracket

### SINGLE PACK

### 2 PACK

### 6 PACK

- Track Bracket for a rolling or a sliding chain link fence gate
- Mounts a 1-5/8" pipe track rail to a chain link fence post sizes from 1-5/8 inch to 2-7/8 inch
- These rolling gate track brackets are simple to install.
- The typical rolling gate track system will require 6 of these track brackets
- Brackets are galvanized steel to prevent rusting and lends to the longevity of the product

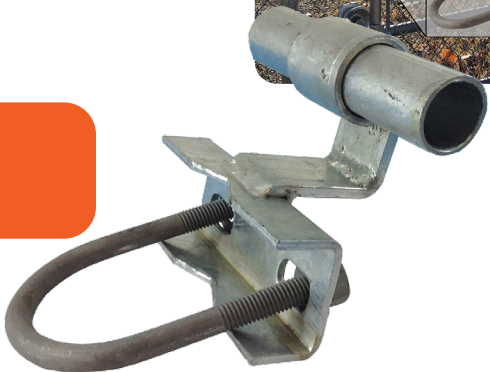

## Wall Mount Chain Link Fence Rolling Gate Track Bracket

### SINGLE PACK

### 2 PACK

### 6 PACK

- For 1-5/8" Track Pipe to be mounted to a flat vertical surface.
- Flat Back Track Bracket for a rolling or a sliding chain link fence gate.
- Mounts a 1-5/8" pipe track rail to a barn, shed, flat wood fence, or any upright flat surface
- These rolling gate track brackets are simple to install.
- The typical rolling gate track system will require 6 of these track brackets
- Brackets are galvanized steel to prevent rust and lend to longevity of product





# CHAIN LINK FENCE HARDWARE

## Rolling/Sliding Gate Track Bracket

1-5/8" TRACK PIPE & 1-5/8" TO 2" POST

SINGLE PACK

6 PACK

- TRACK BRACKET for a rolling or a sliding chain link fence gate
- Mounts a 1-5/8" pipe track rail to a chain link fence post sizes from 1-5/8 inch to 2 inch
- The typical rolling gate track system will require 6 of these track brackets
- Brackets are galvanized chain link fence hardware
- Use with Track Wheels (that mount to 1-5/8" track)
- Also use a Gate Carrier Wheel Set at the outer end of the gate.
- Quantities of Each or 6



## Nylon Cantilever Gate Roller for Chain Link Gates w/Cover

SINGLE PACK

4 PACK

- This Nylon Cantilever Roller has a Graphite-Impregnated Nylon Wheel Designed to Reduce Drag
- Nylon Rollers Reduce Stress on your Overall Gate System Including Gate Openers
- Use a 4" Gate Post and 2-3/8" Gate Frame Pipe with this Nylon Cantilever Roller
- Includes Rolling/Sliding Gate Mounting Hardware and Cover
- Gate Roller Bearings are Double Sealed
- Nylon Cantilevered Gate Rollers Have an Impressive 4000 lbs Load Limit
- These Nylon Gate Rollers Carry a Manufactures Lifetime Warranty



## Chain Link Swivel Style Swing Gate Helper Wheel

1-3/8"

1-5/8"

1-7/8"

Discounts apply to any purchase of two (2) + of this product in course of the same order.

• Order 4 or More Chain Link Gate Swivel Helper Wheels and Save 10%

- These Swivel Gate Helper Wheels fits 3 gate frame sizes 1-3/8", 1-5/8" and 1-7/8"
- Designed to make the gate open and close more freely
- The weight of the gate is supported by the wheel
- Gate swivel wheel supports the gate to prevent it from dragging on the ground
- The 6" wheel provides smoother operation than some smaller wheel designs.
- Easy to install with included installation hardware
- Gate helper wheel frame is galvanized steel to prevent red rust
- **Please measure your gate frame prior to ordering to ensure you order the correct size**



# CHAIN LINK FENCE HARDWARE

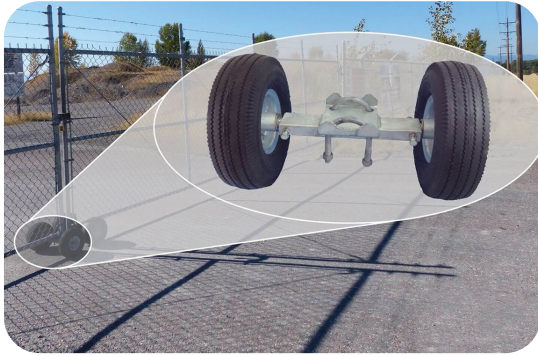

## Pneumatic Rolling Gate Wheel Carrier

### SINGLE PACK

8"

10"

- Use a Pneumatic Rolling Gate Wheel Carrier when the Chain Link Gate Carrier will be Rolling Over Slightly Uneven Ground
- Solid Axle and Ridged Carrier Frame Provide a Solid Wheel Gate Carrier for Residential Gates
- Galvanized Steel Bracket/Body Gate Parts. Rolling Sliding Gate Carrier Wheels are Pneumatic Tires
- These carrier Wheels (Rut Runner) are Easy to Install
- Carrier wheels are designed for 1-7/8" Chain Link Gate Frames
- 12" Axle Width
- Also called Chain Link Gate "Rut Runner"

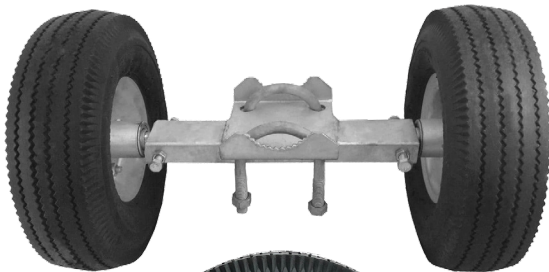

#### 10" Rolling Gate Wheel Carrier

- Outside dimensions from the outside of each tire is 18-1/2"
- Interior dimensions from the inside of each tire 12"
- Each carrier wheel tires are 3-1/8" wide
- The U-Bolt is for a 2" Frame
- Rolling Gate Wheel Carrier Tire Height is 10"
- Rolling Gate Axle Diameter is 5/8"

#### 8" Rolling Gate Wheel Carrier

- Outside dimensions from the outside of each tire 18-1/2"
- Interior dimensions from the inside of each tire is 14-3/8"
- The carrier wheel tires are 2-1/4" wide
- The U-Bolt is for a 2" Frame
- Rolling Gate Wheel Carrier Tire Height is 8"
- Rolling Gate Axle Diameter is 5/8"



## Non Adjustable Rolling Gate Wheel Carrier

### SINGLE PACK

6"

8"

- This chain link fence gate wheel carrier is an essential part of your rolling chain link fence gate.
- This wheel carrier operates a horizontal rolling gate or "sliding gate".
- It works in conjunction with the typical chain link track roller gate system.
- Manufactured from galvanized steel to prevent rust.
- Rolling / Sliding gate carrier wheels includes U-bolts to accommodate gate frames from 1-3/8" to 1-7/8" (2")
- Rolling Gate Rubber wheels come in 6" or 8" diameter, with a total width of 10" wheel axle length.
- Easy to install gate hardware for new and existing gates
- Rolling gate axle diameter is 9/16"



# CHAIN LINK FENCE HARDWARE

## Chain Link Fence Rolling Gate Track Wheel

**GALVANIZED**

**SINGLE PACK**

**2 PACK**

Discounts apply to any purchase of Two (2) 2 Packs of this product in course of the same order.

• Order 4 or more Single Rolling Gate Track Gate Wheels - Save 8%

• Order 20 or more Single Rolling Gate Track Gate Wheels - Save 15%

• Rear track roller for 2" (1-7/8") Gate Frame & 1-5/8" Track Pipe.

• These track wheels are a solid one piece design and are 5-1/4" in diameter of heavy duty cast

• This style is sturdier than the typical split, two-piece style seen offered by other vendors!

• These are the safety track wheel type with a curved retainer to keep gate on track.

• Track Wheel fits a 1-5/8" Track Pipe and a 1-7/8" Chain Link Fence Gate Frame.

• Use Schedule 20 1-5/8" outside diameter pipe (we recommend

• Order (2) 2 PACKS or More Rolling Gate Track Gate Wheels and Save 8%

• Order (10) 2 PACKS or More Rolling Gate Track Gate Wheels and Save 15%

schedule 40) for the roller to roll on.

• These rollers are commercial and industrial strength

• They come with a manufacturer's limited lifetime warranty

• Each rolling chain link gate will require 2 of these Track Wheels, 6 track brackets, and a wheel carrier for the outer end of the gate.

• **Frame and pipe measurements are "outside diameters" - measure yours prior to ordering to ensure you receive correct item**

**\*\* We highly recommend you do not use tubing**

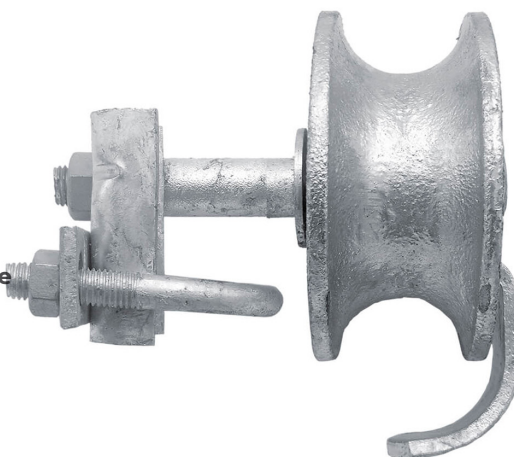
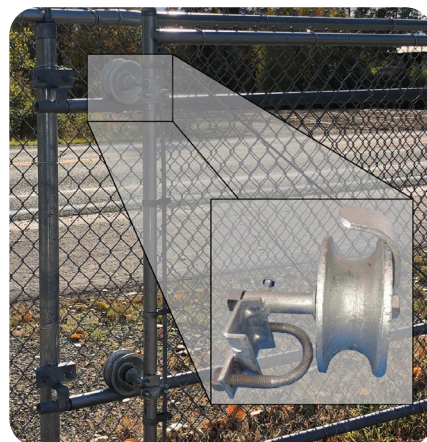

## Cantilever Gate Roller for Chain Link Gate

**SIZE**

**QUANTITY**

**2-3/8" X 1-5/8" (MINI)**

**SINGLE PACK OR 4 PACK**

**3" X 2-3/8"**

**SINGLE PACK OR 4 PACK**

**4" X 2-3/8"**

**SINGLE PACK OR 4 PACK**

• 2-3/8" Mini Cantilevered Gate Roller fits a 2-3/8" "outside diameter" gate post and 1-5/8" gate frame pipe

• 3" Cantilever Gate Roller fits a 3" "outside diameter" gate post and 2-3/8" gate frame pipe

• The 3" Gate Roller Has an Outside Diameter of 6 Inches

• 4" Cantilever Gate Roller fits a 4" "outside diameter" gate post and 2-3/8" gate frame pipe

• All Cantilevered Rollers are maintenance free with double sealed bearings

• 3" and 4" Gate Rollers have a high 3,500 lbs weight capacity

• Cantilevered gate roller assembly has adjustable U shaped bolts designed for easy and sturdy attachment

• Cantilevered gate installations require 4 gate rollers "sandwiching" the gate.

• Typically 2 gate rollers under gate and 2 gate rollers on top of the gate

• Cantilever gates are constructed by adding 1/2 the gate opening width to arrive at the total gate length

• Cantilever gate rollers can be used on a variety of fence types including: chain link, wood privacy, ornamental iron etc

**Check local codes for gate roller cover compliance**

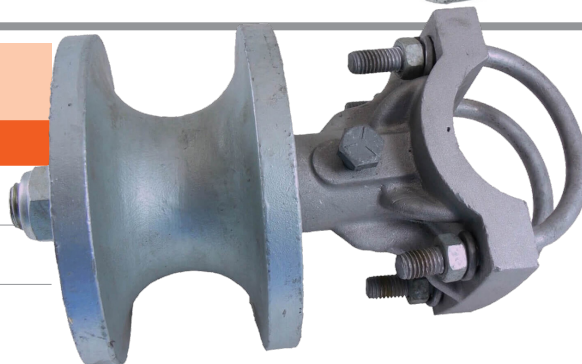



# CHAIN LINK FENCE HARDWARE

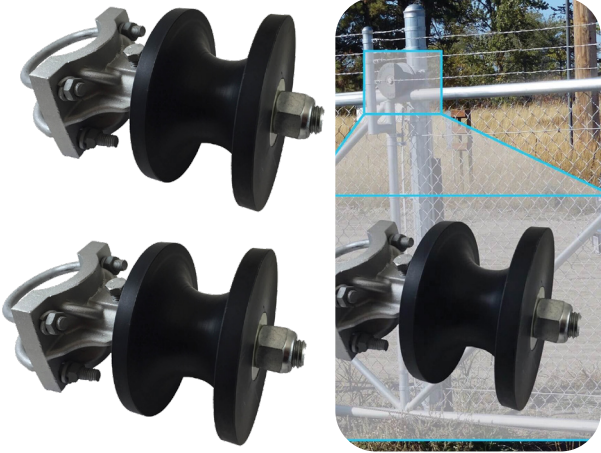

## Nylon Cantilevered Nylon Gate Roller

3" X 2-3/8"

### SINGLE PACK

- Rollers are for 3" "outside diameter" posts and 2-3/8" "outside diameter" gate frames.
- 6 Inch diameter wheel is nylon for long life and smoother operation than cast iron
- The gate roller body assembly is manufactured from galvanized

### 4 PACK

- steel to prevent rusting
- Gate Roller Assembly has adjustable U shape bolts designed for easy attachment
- **Please measure your gate posts and gate frames prior to ordering to ensure your product will fit correctly**



## Nylon Chain Link Fence Rolling Gate Track Wheel

### SINGLE PACK

Discounts apply to any purchase of Two (2) 2 Packs of this product in course of the same order.

- Order 4 or more Single Rolling Gate Track Gate Wheels - Save 8%
- Order 20 or more Single Rolling Gate Track Gate Wheels - Save 15%
- Track Wheel Rolling, Sliding Gate Rear Track Roller for 2" (1-7/8") Gate Frame & 1-5/8" Track Pipe.
- Use Schedule 20 1-5/8" outside diameter pipe (we recommend schedule 40) for the roller to roll on.
- High quality ball bearings provide smooth operation with nylon rollers for less friction and less bind!
- Track roller has a safety track wheel type with a curved retainer to help

### 2 PACK

- Order (2) 2 PACKS or More Rolling Gate Track Gate Wheels and Save 8%
- Order (10) 2 PACKS or More Rolling Gate Track Gate Wheels and Save 15%
- the gate to stay on track.
- Commercial/Industrial strength with a manufacturer's lifetime warranty.
- Each rolling chain link gate will require 2 of these Track Wheels
- **Please measure your gate frame and track pipe prior to order to ensure proper fit**
- **\*\* We highly recommend you do not use tubing.**



## Chain Link Swing Gate Helper Wheel

### SINGLE PACK

- Order 10 or More Chain Link Swing Gate Helper Wheels and Save 20%
- Gate Helper Wheel supports gate to prevent the gate from dragging on the ground
- The 6" diameter wheel provides smoother operation than smaller wheel designs.
- Easy to Install with included U-bolt and nuts Gate Helper Wheel frame is

- manufactured from galvanized steel to prevent rust.
- Use this support wheel with 1-3/8" to 1-7/8" "outside diameter" pipe gate frames.
- **Please measure your gate frame pipe prior to ordering to ensure product will fit properly**

# CHAIN LINK FENCE HARDWARE

## Chain Link Fence Rolling Gate Wheel Carrier

**RUBBER - 6"**

**SINGLE PACK**

**2 PACK**

Discounts apply to any purchase of Two (2) 2 Packs of this product in course of the same order.

• Order 2 or More Chain Link Fence Rolling Gate Wheel Carrier -Rubber 6" Save 10%

- Rolling Gate Carrier Wheels for chain link track gate frames from 1-3/8" to 1-7/8"
- Rubber wheels are 6" in diameter with a total width of 10" wheel axle length.
- Solid axle ridged carrier frame provide a solid gate carrier for residential gates
- This wheel carrier operates a horizontal rolling gate or "sliding gate"
- These rolling gate carrier wheels are hard rubber tires
- Easy to Install, works in conjunction with the typical chain link track roller gate system
- **Please measure you gate frame prior to ordering to ensure the product will fit correctly**

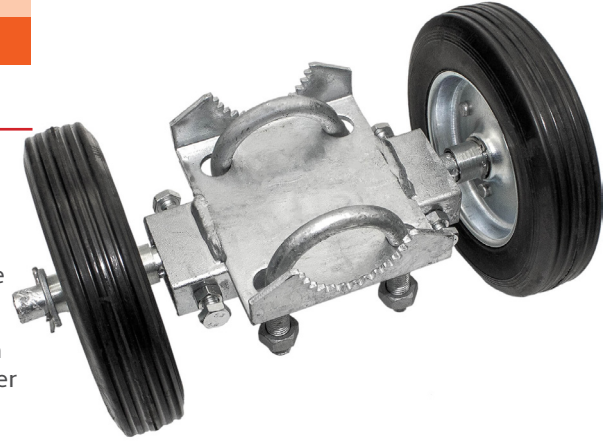

## 6 Inch Wide Stance Rolling Gate Wheel Carrier

**SINGLE PACK**

- Rolling Gate Carrier Wheels for Chain Link Track Gate Frames fits Gate Frames from 1-5/8" to 1-7/8"
- Rubber wheels are 6" in diameter, with a tire width of 1-1/2", Inside axle length of 12" wheel to wheel
- Total width wheel carrier assembly is 15" from outside of wheel to outside of wheel.
- Solid Axle and Ridged Carrier Frame Provide a Solid Wheel Gate Carrier for Residential Gates
- Rolling Sliding Gate Carrier Wheels are Hard Rubber Tires
- This wheel carrier operates a horizontal rolling gate or "sliding gate"
- Easy to install, It works in conjunction with the typical chain link track roller gate system.

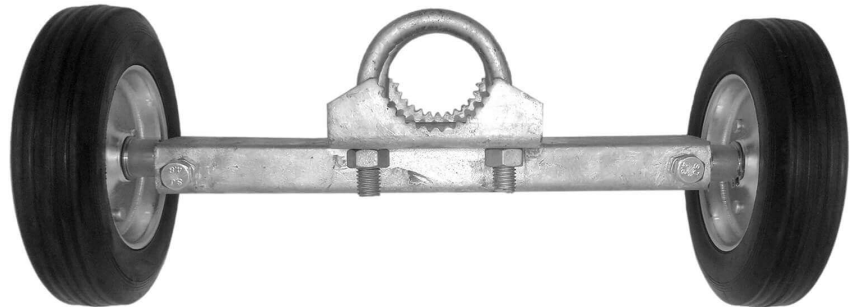

**HAVE QUESTIONS?  
NEED ANSWERS?**

E-mail: [tom@jakesales.com](mailto:tom@jakesales.com)

Phone: (406) 752-5253

Website: [jakesales.com](http://jakesales.com)

# Jake Sales

[www.jakesales.com](http://www.jakesales.com)

# CHAIN LINK FENCE HARDWARE



## 6" Chain Link Rolling Gate Hardware Kit

### (CHAIN LINK FENCE GATE PARTS)

**6" RUT RUNNER; 2 TRACK WHEELS; 6 TRACK BRACKETS;  
1 ROLO LATCH**

#### ROLLING/SLIDING GATE TRACK BRACKET

- Track bracket for a rolling or a sliding chain link fence gate.
- This one mounts a 1-5/8" pipe track rail to a chain link fence post sizes from 1-5/8 inch to 2-7/8 inch.
- The typical rolling gate track system will require 6 of these track brackets.
- Brackets are manufactured from galvanized steel to prevent rusting
- Use with Track Wheels that mount to 1-5/8" track
- Also use a gate carrier wheel set at the outer end of the gate.

#### CHAIN LINK ROLLING GATE TRACK ROLLER

- Track wheel rolling sliding gate rear track roller for 2" (1-7/8") gate frame & 1-5/8" track pipe.
- The track wheels are a solid one piece design and are 5-1/4" in diameter heavy duty cast
- These wheels are far superior to the two piece, riveted together, metal half-wheels seen in other kits

#### Non Adjustable ROLLING GATE 6" WHEEL CARRIER

- This wheel carrier operates a horizontal rolling gate or "sliding gate"
- It works in conjunction with the typical chain link track roller gate system.
- Rolling/Sliding gate carrier wheels for chain link track gate frames from 1-3/8" to 1-7/8"
- Rolling gate rubber wheels are 6" in diameter with a total width of 10" wheel axle length.
- Includes U-bolts to accommodate gate Frames Sizes 1-3/8" thru 1-7/8".
- Manufactured from galvanized steel on gate wheel parts to prevent rusting
- Easy to install gate hardware for new or existing gates.

#### Chain Link Fence "ROLO" ROLLING GATE LATCH

- For 1-5/8" & 1-7/8" (2") chain link gate pipe sizes.
- This latch is great for use with rolling chain link gates, sliding gates, and cantilevered rolling gates.
- The ROLO can be padlocked for security
- *Requires two brace bands to attach to the "Latch Post" - purchase brace bands based on the size of your post*



# CHAIN LINK FENCE HARDWARE

## 6" Chain Link Rolling Gate Hardware Kit

### (CHAIN LINK FENCE GATE PARTS)

#### 6" RUT RUNNER, 2 TRACK WHEELS, 6 WALL MOUNTED TRACK BRACKETS, 1 ROLO LATCH

##### ROLLING/SLIDING GATE TRACK BRACKET for 1-5/8" Track Pipe

- Wall mounted Track Brackets for a rolling or a sliding chain link fence gate
- These brackets support a 1-5/8" pipe track.
- The typical rolling gate track system will require 6 of these track brackets.
- Brackets are galvanized steel to prevent rusting
- Use with Track Wheels that mount to 1-5/8" track.

##### CHAIN LINK ROLLING GATE TRACK ROLLER

- Track Wheel Rolling/Sliding Gate Rear Track Roller for 2" (1-7/8") Gate Frame
- Track wheel is designed to run on a 1-5/8" Track Pipe.
- Track wheel has a curved safety retainer to keep gate on the track
- The Track Wheels are a Solid One Piece design and are about 5-1/4" in diameter

##### Non Adjustable ROLLING GATE 6" WHEEL CARRIER

- This chain link fence gate wheel carrier is an essential part of your rolling chain link fence gate.
- This wheel carrier operates a horizontal rolling gate or "sliding gate".
- It works in conjunction with the typical chain link track roller gate system.
- It is galvanized to last a long time, and easy to install
- Rolling or Sliding Gate Carrier Wheels for Chain Link Track Gate
- Fits gate frames measuring 1-5/8" to 1-7/8".
- Rolling Gate Rubber wheels are 6" in diameter, with a total width of 10" wheel axle length.
- Includes U-bolts to Accommodate Rolling Gate-Sliding Gate Frames Sizes 1-5/8" thru 1-7/8". Galvanized Steel Bracket/Body on Gate Wheel Parts Insures Long Rolling Gate Wheel Bracket Life.
- Easy to Install Chain Link Fence Rolling/Sliding Gate hardware. Gate Wheel for New or Existing Gates.

##### Chain Link Fence "ROLO" ROLLING GATE LATCH

- For 1-5/8" & 1-7/8" (2") chain link gate pipe sizes.
- This latch is great for use with rolling chain link gates, sliding gates, and cantilevered rolling gates.
- The ROLO can be padlocked for security

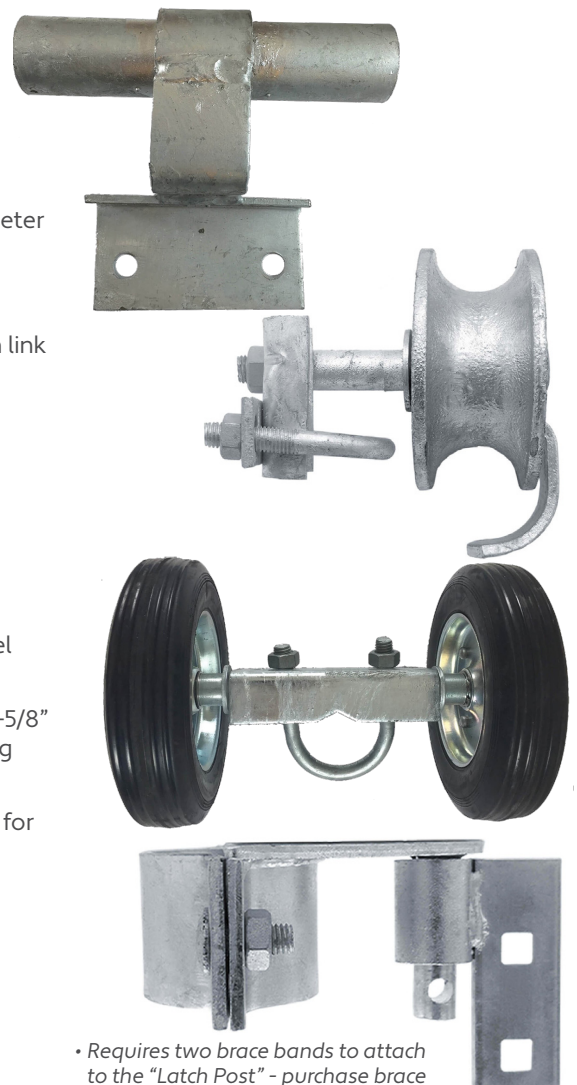
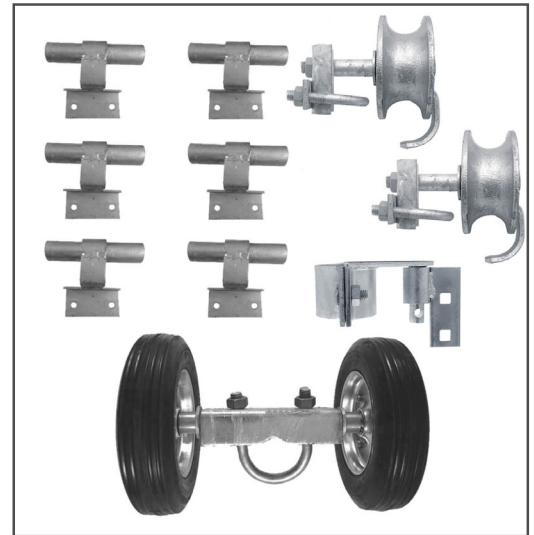

• Requires two brace bands to attach to the "Latch Post" - purchase brace bands based on the size of your post

# WROUGHT IRON FENCE CAP

## Ornamental Wrought Iron Fence Cap (2" x 2")

Discounts apply to any purchase of Two (2) 2 Packs of this product in course of the same order.

• Order 2 or more Wrought Iron Fence Post Caps and Save 10%

• Order 7 or more Wrought Iron Fence Post Caps and Save 50%

- 2" x 2" Ornamental Iron Fence Post Cap Designed for 2" by 2" Exterior Rounded Corner Fence Post Dimensions.
- Gives Your Ornamental Fence Post a Finished Look and Keeps Water/Snow Out for Longer Fence Life
- Ornamental wrought iron fence post caps are powder coated black for long life and to match black ornamental iron fences.
- Ornamental Wrought Iron Post Cap is Black Coated Steel for Years of Life Expectancy.
- This is the Most Common Size Wrought Iron Fence Post Cap Size

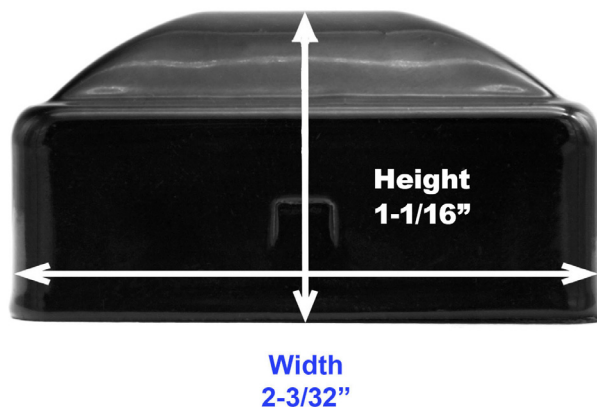

**Pay for Only  
What You Need  
NOT for Shipping**

**FAST & FREE SHIPPING  
TO ALL 50 US STATES**





# SCREW BITS, DRIVERS, HOLDERS & ADAPTERS

## TORX Driver Bit Set - 2 inch

T10, T15, T20, T25, T30, T40 – Quick-Change Shank

### SINGLE PACK

- Fits All Standard Torx/Star-head Fasteners, Fits Securely in Drill Chucks
  - High Quality Industrial Grade Tool Steel SK2 - Resists Stripping and Cam-Out
  - For Professional Operations & Demanding Industries
- Professional Grade Drill Drive Bit Tips are Color Coded for Easy Bit Size Selection
- T10 Star/Torx Drive Bit Color is Yellow
  - T15 Star/Torx Drive Bit Color is Red
  - T20 Star/Torx Drive Bit Color is Purple
  - T25 Star/Torx Drive Bit Color is Green
  - T30 Star/Torx Drive Bit Color is Brown
  - T40 Star/Torx Drive Bit Color is Blue



## TORX Driver Bit Set - 2 inch

T15, T20, T25, T30, T40 – Quick-Change Shank

### SINGLE PACK

- 1/4 inch Standard Quick Change Shank for Fast Swaps
  - Fits All Standard Torx/Star-head Fasteners, Fits Securely in Drill Chucks
  - High Quality Industrial Grade Tool Steel SK2 - Resists Stripping and Cam-Out
  - For Professional Operations & Demanding Industries
- Professional Grade Drill Drive Bit Tips are Color Coded for Easy Bit Size Selection
- T15 Star/Torx Drive Bit Color is Red
  - T20 Star/Torx Drive Bit Color is Purple
  - T25 Star/Torx Drive Bit Color is Green
  - T30 Star/Torx Drive Bit Color is Brown
  - T40 Star/Torx Drive Bit Color is Blue



## TORX Driver Bit Set - 1 inch

T10, T15, T20, T25, T30, T40 – Quick-Change Shank

### SINGLE PACK

- 1/4 inch Standard Shaft Size, Fits Securely in Drill Chucks
  - Fits All Standard Torx/Star-head Fasteners (T10, T15, T20, T25, T30, T40)
  - High Quality Industrial Grade Tool Steel SK2 - Resists Stripping and Cam-Out
  - For Professional Operations & Demanding Industries
- Professional Grade Drill Drive Bit Tips are Color Coded for Easy Bit Size Selection
- T10 Star/Torx Drive Bit Color is Yellow
  - T15 Star/Torx Drive Bit Color is Red
  - T20 Star/Torx Drive Bit Color is Purple
  - T25 Star/Torx Drive Bit Color is Green
  - T30 Star/Torx Drive Bit Color is Brown
  - T40 Star/Torx Drive Bit Color is Blue





# SCREW BITS, DRIVERS, HOLDERS & ADAPTERS



## 1 Inch - TORX Driver Bit Set

HIGH QUALITY COLOR CODED

### SINGLE PACK

Kit Contains (in Convenient Holder):

- 1 – T10
- 2 – T15
- 2 – T20
- 2 – T25
- 2 – T30
- 1 – T40
- All Torx Bit Have Sizes Engraved on Driver Bit

- All Bits Are Made of High Quality Tool Grade S2 Industrial Steel for Long Torx/Star Driver Bit Life.
- Torx/Star Drive Bit Set is Impact Rated.
- All Torx/Star Bits Are Color Coded for Quick Bit Size Selection.
- 1/4" Bit Hex Shaft Fits Standard Drills



## 2 Inch - TORX Driver Bit Set

HIGH QUALITY COLOR CODED

### SINGLE PACK

Kit Contains (in Convenient Holder):

- 1 – T10
- 2 – T15
- 2 – T20
- 2 – T25
- 2 – T30
- 1 – T40
- All Torx Bit Have Sizes Engraved on Driver Bit

- All Bits Are Made of High Quality Tool Grade S2 Industrial Steel for Long Torx/Star Driver Bit Life.
- Torx/Star Drive Bit Set is Impact Rated.
- All Torx/Star Bits Are Color Coded for Quick Bit Size Selection.
- 1/4" Bit Hex Shaft Fits Standard Drills

## Long Magnetic Bit Holder Extension

1/4" X 2"

### SINGLE PACK

Discounts apply to any purchase of five (5) + of this product in course of the same order.

- Order 5 or More MAGNETIC BIT HOLDER EXTENSION: 1/4" x 2" Save 60%

- This 2" extension holds 1/4" diameter drill driver bits
- Typically used to hold 1" or longer bit inserts
- This bit holder is magnetic. It helps hold bit and screw to make each job simpler.

- Also Retaining the bit is the C-Ring retainer clip just inside the end of the extension.
- This bit extender also has a quick change shank making it faster to take in and out of the drill.



# SCREW BITS, DRIVERS, HOLDERS & ADAPTERS

## T10 – Torx/Star Driver Bit

1 INCH

10 PACK

Discounts apply to any purchase of three (3) + of this product in course of the same order.

• Order 3 or More Qty 10 - 1 Inch  
T10 Torx/Star Driver Bits Save 20%

• Order 7 or More Qty 10 - 1 Inch  
T10 Torx/Star Driver Bits Save 30%

- 1/4 inch Standard Shank
- Fits All T10 Torx/Star-head Fasteners, Fits Securely in Drill Chucks
- High Quality Industrial Grade Tool Steel SK2 - Resists Stripping and Cam-Out
- For Professional Operations & Demanding Industries
- Professional Grade Drill Drive Bit Tips are Color Coded for Easy Bit Size Selection
- T10 Star/Torx Drive Bit Color is Yellow



## T10 – Torx/Star Driver Bit

2 INCH

5 PACK

Discounts apply to any purchase of three (3) + of this product in course of the same order.

• Order 3 or More - Qty 5 - 2 Inch  
T10 Torx/Star Driver Bits Save 20%

• Order 7 or More - Qty 5 - 2 Inch  
T10 Torx/Star Driver Bits Save 30%

- 1/4 inch Standard Quick Change Shank for Fast Swaps
- High Quality Industrial Grade Tool Steel SK2 - Resists Stripping and Cam-Out
- Fits All T10 Torx/Star-head Fasteners, Fit Securely in Drill Chucks
- For Professional Operations & Demanding Industries
- Professional Grade Drill Drive Bit Tips, Color Coded for Easy Bit Size Selection
- T10 Star/Torx Drive Bit Color is Yellow



## T10 – Torx/Star Driver Bit

6 INCH

SINGLE PACK

Discounts apply to any purchase of five (5) + of this product in course of the same order.

• Order 5 or More 6 Inch T10 Torx/Star Driver Bits Save 46%

- 1/4 inch Standard Quick Change Shank for Fast Swaps
- Fits All T10 Torx/Star-head Fasteners, Fits Securely in Drill Chucks
- High Quality Industrial Grade Tool Steel SK2 - Resists Stripping and Cam-Out
- For Professional Operations & Demanding Industries
- These Are Professional Grade Drill Drive Bit Tips



# SCREW BITS, DRIVERS, HOLDERS & ADAPTERS



## T15 – Torx/Star Driver Bit

### 1 INCH - 10 PACK

Discounts apply to any purchase of three (3) + of this product in course of the same order.

- |  |  |
|--|--|
| <ul style="list-style-type: none"> <li>• Order 3 or More Qty 10 - 1 Inch T15 Torx/Star Driver Bits Save 20%</li> </ul> | <ul style="list-style-type: none"> <li>• Order 7 or More Qty 10 - 1 Inch T15 Torx/Star Driver Bits Save 30%</li> </ul> |
|--|--|
- 1/4 inch Standard Shank, Fits Securely in Drill Chucks
  - Fits All T15 Torx/Star-head Fasteners
  - High Quality Industrial Grade Tool Steel SK2 - Resists Stripping and Cam-Out
  - For Professional Operations & Demanding Industries
  - Professional Grade Drill Drive Bit Tips are Color Coded for Easy Bit Size Selection
  - T15 Star/Torx Drive Bit Color is Red

## T15 – Torx/Star Driver Bit

### 2 INCH - 5 PACK

Discounts apply to any purchase of three (3) + of this product in course of the same order.

- |  |  |
|--|--|
| <ul style="list-style-type: none"> <li>• Order 3 or More Qty 10 - 1 Inch T15 Torx/Star Driver Bits Save 20%</li> </ul> | <ul style="list-style-type: none"> <li>• Order 7 or More Qty 10 - 1 Inch T15 Torx/Star Driver Bits Save 30%</li> </ul> |
|--|--|
- 1/4 inch Standard Quick Change Shank for Fast Swaps
  - Fits All T15 Torx/Star-head Fasteners, Fit Securely in Drill Chucks
  - High Quality Industrial Grade Tool Steel SK2 - Resists Stripping and Cam-Out
  - For Professional Operations & Demanding Industries
  - Professional Grade Drill Drive Bit Tips, Color Coded for Easy Bit Size Selection
  - T15 Star/Torx Drive Bit Color is Red

## T15 – Torx/Star Driver Bit

### 3-1/2 INCH - 5 PACK

### 6 INCH - SINGLE PACK

Discounts apply to any purchase of three (3) + of this product in course of the same order.

Discounts apply to any purchase of five (5) + of this product in course of the same order.

- |  |   |
|--|---|
| <ul style="list-style-type: none"> <li>• Order 3 or More - Qty 5 - 3-1/2 Inch T15 Torx/Star Driver Bits Save 20%</li> <li>• Order 7 of More - Qty 5 - 3-1/2 Inch T15 Torx/Star Driver Bits Save 30%</li> </ul> | <ul style="list-style-type: none"> <li>• Order 5 or More 6 Inch T15 Torx/Star Driver Bits Save 46%</li> </ul> |
|--|---|
- 1/4 inch Standard Quick Change Shank for Fast Swaps
  - Fits All T15 Torx/Star-head Fasteners, Fits Securely in Drill Chucks
  - Steel SK2 - Resists Stripping and Cam-Out
  - For Professional Operations & Demanding Industries
  - These Are Professional Grade Drill Drive Bit Tips





# SCREW BITS, DRIVERS, HOLDERS & ADAPTERS



## T20 – Torx/Star Driver Bit

### 1 INCH - 10 PACK

Discounts apply to any purchase of three (3) + of this product in course of the same order.

- Order 3 or More Qty 10 - 1 Inch T20 Torx/Star Driver Bits Save 20%
- Order 7 or More Qty 10 - 1 Inch T20 Torx/Star Driver Bits Save 30%

- 1/4 inch Standard Shank Fits Securely in Drill Chucks
- Fits All T20 Torx/Star-head Fasteners
- High Quality Industrial Grade Tool Steel SK2 - Resists Stripping and Cam-Out
- For Professional Operations & Demanding Industries
- Professional Grade Drill Drive Bit Tips are Color Coded for Easy Bit Size Selection
- T20 Star/Torx Drive Bit Color is Purple

## T20 – Torx/Star Driver Bit

### 2 inch - 5 pack

Discounts apply to any purchase of three (3) + of this product in course of the same order.

- Order 3 or More Qty 5 - 2 Inch T20 Torx/Star Driver Bits Save 20%
- Order 7 or More Qty 5 - 2 Inch T20 Torx/Star Driver Bits Save 30%

- 1/4 inch Standard Quick Change Shank for Fast Swaps
- Fits All T20 Torx/Star-head Fasteners, Fit Securely in Drill Chucks
- High Quality Industrial Grade Tool Steel SK2 - Resists Stripping and Cam-Out
- For Professional Operations & Demanding Industries
- Professional Grade Drill Drive Bit Tips, Color Coded for Easy Bit Size Selection
- T20 Star/Torx Drive Bit Color is Purple

## T20 – Torx/Star Driver Bit

### 3-1/2 INCH - 5 PACK

Discounts apply to any purchase of three (3) + of this product in course of the same order.

- Order 3 or More - Qty 5 - 3-1/2 Inch T20 Torx/Star Driver Bits Save 20%
- Order 7 of More - Qty 5 - 3-1/2 Inch T20 Torx/Star Driver Bits Save 30%

- 1/4 inch Standard Quick Change Shank for Fast Swaps
- Fits All T20 Torx/Star-head Fasteners, Fits Securely in Drill Chucks
- High Quality Industrial Grade Tool Steel SK2 - Resists Stripping and

### 6 INCH - SINGLE PACK

Discounts apply to any purchase of five (5) + of this product in course of the same order.

- Order 5 or More 6 Inch T20 Torx/Star Driver Bits Save 46%

- Cam-Out
- For Professional Operations & Demanding Industries
- These are Professional Grade Drill Drive Bit Tips



# SCREW BITS, DRIVERS, HOLDERS & ADAPTERS



## T25 – Torx/Star Driver Bit

### 1 INCH - 10 PACK

Discounts apply to any purchase of three (3) + of this product in course of the same order.

- Order 3 or More Qty 10 - 1 Inch T25 Torx/Star Driver Bits Save 20%
- Order 7 or More Qty 10 - 1 Inch T25 Torx/Star Driver Bits Save 30%
- 1/4 inch Standard Shank, Fits Securely in Drill Chucks
- Fits All T25 Torx/Star-head Fasteners
- High Quality Industrial Grade Tool Steel SK2 - Resists Stripping and Cam-Out
- For Professional Operations & Demanding Industries
- Professional Grade Drill Drive Bit Tips are Color Coded for Easy Bit Size Selection
- T25 Star/Torx Drive Bit Color is Green

## T25 – Torx/Star Driver Bit

### 2 INCH - 5 PACK

Discounts apply to any purchase of three (3) + of this product in course of the same order.

- Order 3 or More Qty 5 - 2 Inch T25 Torx/Star Driver Bits Save 20%
- Order 7 or More Qty 5 - 2 Inch T25 Torx/Star Driver Bits Save 30%
- 1/4 inch Standard Quick Change Shank for Fast Swaps
- Fits All T25 Torx/Star-head Fasteners, Fits Securely in Drill Chucks
- High Quality Industrial Grade Tool Steel SK2 - Resists Stripping and Cam-Out
- For Professional Operations & Demanding Industries
- Professional Grade Drill Drive Bit Tips, Color Coded for Easy Bit Size Selection
- T25 Star/Torx Drive Bit Color is Green

## T25 – Torx/Star Driver Bit

### 3-1/2" - SINGLE PACK

Discounts apply to any purchase of five (5) + of this product in course of the same order.

- Order 5 or More 3-1/2 Inch T25 Torx/Star Driver Bits Save 60%
- Order 25 or More 3-1/2 Inch T25 Torx/Star Driver Bits Save 75%

- 1/4 inch Standard Quick Change Shank for Fast Swaps
- Fits All T25 Torx/Star-head Fasteners, Fits Securely in Drill Chucks

### 6" - SINGLE PACK

Discounts apply to any purchase of five (5) + of this product in course of the same order.

- Order 5 or More 6 Inch T25 Torx/Star Driver Bits Save 46%

- High Quality Industrial Grade Tool Steel SK2 - Resists Stripping and Cam-Out
- For Professional Operations & Demanding Industries
- These Are Professional Grade Drill Drive Bit Tips

# SCREW BITS, DRIVERS, HOLDERS & ADAPTERS

## T30 – Torx/Star Driver Bit

**1 INCH - 10 PACK**

Discounts apply to any purchase of three (3) + of this product in course of the same order.

- Order 3 or More Qty 10 - 1 Inch T30 Torx/Star Driver Bits Save 20%
- Order 7 or More Qty 10 - 1 Inch T30 Torx/Star Driver Bits Save 30%
- 1/4 inch Standard Shank, Fits Securely in Drill Chucks
- Fits All T30 Torx/Star-head Fasteners
- High Quality Industrial Grade Tool Steel SK2 - Resists Stripping and Cam-Out
- For Professional Operations & Demanding Industries
- Professional Grade Drill Drive Bit Tips are Color Coded for Easy Bit Size Selection
- T30 Star/Torx Drive Bit Color is Brown



## T30 – Torx/Star Driver Bit

**2 inch - 5 pack**

Discounts apply to any purchase of three (3) + of this product in course of the same order.

- Order 3 or More Qty 5 - 2 Inch T30 Torx/Star Driver Bits Save 20%
- Order 7 or More Qty 5 - 2 Inch T30 Torx/Star Driver Bits Save 30%
- 1/4 inch Standard Quick Change Shank for Fast Swaps
- Fits All T30 Torx/Star-head Fasteners, Fits Securely in Drill Chucks
- High Quality Industrial Grade Tool Steel SK2 - Resists Stripping and Cam-Out
- For Professional Operations & Demanding Industries
- Professional Grade Drill Drive Bit Tips, Color Coded for Easy Bit Size Selection
- T30 Star/Torx Drive Bit Color is Brown



## T30 – Torx/Star Driver Bit

**3-1/2" - 5 PACK**

**6" - SINGLE PACK**

Discounts apply to any purchase of five (5) + of this product in course of the same order.

Discounts apply to any purchase of five (5) + of this product in course of the same order.

- |   |   |
|---|---|
| <ul style="list-style-type: none"> <li>• Order 5 or More 3-1/2 Inch T30 Torx/Star Driver Bits Save 60%</li> <li>• Order 25 or More 3-1/2 Inch T30 Torx/Star Driver Bits Save 75%</li> </ul> | <ul style="list-style-type: none"> <li>• Order 5 or More 6 Inch T30 Torx/Star Driver Bits Save 46%</li> </ul> |
|---|---|
- 1/4 inch Standard Quick Change Shank for Fast Swaps
  - Fits All T30 Torx/Star-head Fasteners, Fits Securely in Drill Chucks
  - High Quality Industrial Grade Tool Steel SK2 - Resists Stripping and Cam-Out
  - For Professional Operations & Demanding Industries
  - These Are Professional Grade Drill Drive Bit Tips





# SCREW BITS, DRIVERS, HOLDERS & ADAPTERS



## SIZES

- 1/4"
- 5/16"
- 3/8"
- 7/16"
- 1/2"

## T40 – Torx/Star Driver Bit

### 1 INCH - 10 PACK

Discounts apply to any purchase of three (3) + of this product in course of the same order.

- Order 3 or More Qty 10 - 1 Inch T40 Torx/Star Driver Bits Save 20%
- Order 7 or More Qty 10 - 1 Inch T40 Torx/Star Driver Bits Save 30%
- 1/4 inch Standard Shank, Fits All T40 Torx/Star-head Fasteners
- High Quality Industrial Grade Tool Steel SK2 - Resists Stripping and Cam-Out
- For Professional Operations & Demanding Industries
- Professional Grade Drill Drive Bit Tips are Color Coded for Easy Bit Size Selection
- T40 Star/Torx Drive Bit Color is Blue

## T40 – Torx/Star Driver Bit

### 2 INCH - 5 PACK

Discounts apply to any purchase of three (3) + of this product in course of the same order.

- Order 3 or More Qty 5 - 1 Inch T40 Torx/Star Driver Bits Save 20%
- Order 7 or More Qty 5 - 1 Inch T40 Torx/Star Driver Bits Save 30%
- 1/4 inch Standard Quick Change Shank for Fast Swaps
- Fits All T40 Torx/Star-head Fasteners, Fits Securely in Drill Chucks
- High Quality Industrial Grade Tool Steel SK2 - Resists Stripping and Cam-Out
- For Professional Operations & Demanding Industries
- Professional Grade Drill Drive Bit Tips are Color Coded for Easy Bit Size Selection
- T40 Star/Torx Drive Bit Color is Blue

## Magnetic Nut Drivers w/ Quick Change Shank

### INDIVIDUAL DRIVERS

Discounts apply to any purchase of five (5) + of this product in course of the same order.

- Order 5 or More Magnetic Nut Driver or other Nut Drivers and Save 50%
- 1/4 inch Standard Shank Fits Securely in Standard Drill Chucks
- 1-3/4 inch Overall Length
- Nut Drivers Come in 1/4, 5/16, 3/8, 7/16, & 1/2 inch sizes
- These magnetic nut drivers are made from industrial-grade, hardened and tempered tool-steel

### DRIVER SET

Discounts apply to any purchase of two (2) + of this product in course of the same order.

- Order 2 or More of Magnetic Nut Driver Sets and Save 20%
- Professional Grade Drill Drive Bit Tips. These Nut Drivers Resist Stripping and Cam-Out
- For Professional Operations & Demanding Industries
- Uses Include Driving Some Heavy Duty Hex-Head Screws, Nut, Bolts

# SCREW BITS, DRIVERS, HOLDERS & ADAPTERS

## #1 Square Head Driver Drill Bit Tip (2 INCH)

2 PACK

10 PACK

- 1/4 inch Standard Shank Square Bit
- Engineered for Installing #1 Square Head Screws
- Square Bits Fit Securely in Drill Chucks
- High Quality Industrial Grade Tool Steel SK2 - Resists Stripping and Cam-Out
- For Professional Operations & Demanding Industries
- Professional Grade; Square Bit Drill Drive Bit Tips
- Convenient 2" Length Square Head Driver



## #2 Square Head Driver Drill Bit Tip (2 INCH)

2 PACK

10 PACK

- 1/4 inch Standard Shank Square Bit
- Engineered for Installing #2 Square Head Screws
- Square Bits Fit Securely in Drill Chucks
- High Quality Industrial Grade Tool Steel SK2 - Resists Stripping and Cam-Out
- For Professional Operations & Demanding Industries
- Professional Grade; Square Bit Drill Drive Bit Tips
- Convenient 2" Length Square Head Driver



## #2 Phillips Head Driver Drill Bit Tips

SIZE

QUANTITY

2 INCH

2 PACK

2 INCH

10 PACK

6 INCH

1 PACK

- 1/4 inch Standard Shank PH2 Bits, Engineered for Installing #2 Phillips Head Screws
- Fit Securely in Drill Chucks
- High Quality Industrial Grade Tool Steel SK2 - Resists Stripping and Cam-Out
- For Professional Operations & Demanding Industries
- Professional Grade; PH2 Bits Drill Drive Bit Tips



# SCREW BITS, DRIVERS, HOLDERS & ADAPTERS

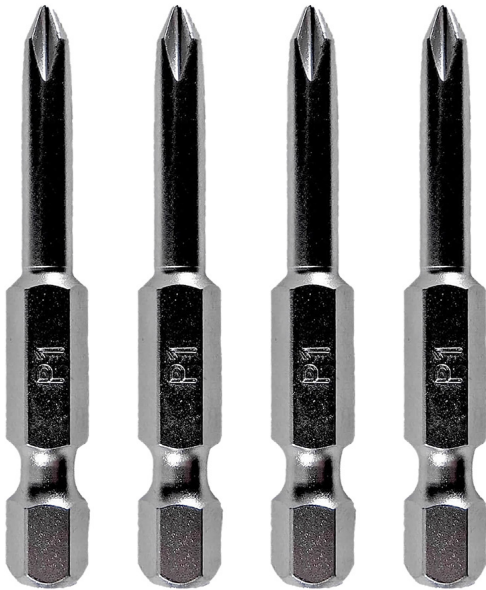

## #1 X 2" Phillips head Driver Bit Tip

SIZE	QUANTITY
2 INCH	2 PACK
2 INCH	4 PACK
2 INCH	6 PACK

- Standard size #1 Phillips Driver Bit works with Industry Standard Phillips Screws
- 2 Inches in Length with a Standard Size 1/4" Shank for easy change out with most Drills and Magnetic Bit Holders
- Manufactured from High Quality Industrial Grade Tool Steel will Resist Stripping and "Cam-Out"
- Use with #1 Standard Phillips Screws and Other Fasteners



## Drywall Phillips Head Driver Drill Bit Tip

SIZE	QUANTITY
1 INCH	2 PACK
1 INCH	10 PACK

- 1/4 inch Standard Shank Drywall Bit, Fits Securely in Drill Chucks
- Engineered for Installing Drywall Phillips Head Screws
- High Quality Industrial Grade Tool Steel SK2 - Resists Stripping and Cam-Out
- For Professional Operations & Demanding Industries
- Professional Grade Drill Drive Bit Tips Drywall Bit
- Sets Drywall Screws for Easier Mudding/Taping

ALL orders shipping in the United States ship for

**FREE**

Paid orders received before 12 noon, ship the same business day.





# NAILS



## 15 Degree Wire Weld Coiled Roofing Nails

SIZE	QUANTITY
1-1/4" X .120" ROOFING	FULL BOX - 7200 COUNT

### Electro-Galvanized

- Used for Composition Roofing Shingles and Roofing Felt
- Used in Most 15 degree Coil Roofing Nailers -Grip Rite, Bostitch, Hitachi, Makita, DeWalt and others
- Wide Head .38" assists in holding nails in place and reduces pull out

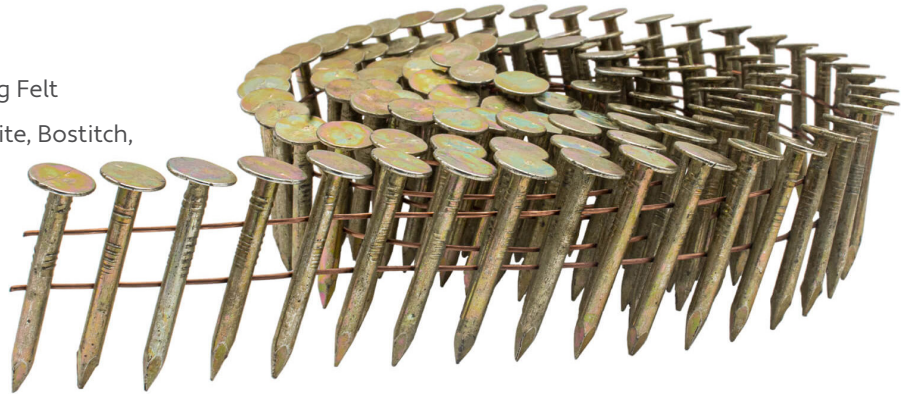

## 15 Degree Wire Weld Coiled Siding/Fencing Nails

SIZE	QUANTITY
1-3/4" X .092" SIDING/FENCING	FULL BOX - 3000 COUNT
2" X .092" SIDING/FENCING	FULL BOX - 3000 COUNT
2-3/16" X .092" SIDING/FENCING	FULL BOX - 3000 COUNT

### Hot-Galvanized

- 15 Degree Hot Galvanized\*\*, Ring Shank Nails for siding, roof and wall sheathing, pressure treated fencing
- Can be used for attaching Cement Board, Clapboard, Vinyl, T1-11 Siding, Plywood to Floor Joists
- Nails are galvanized to prevent rusting with a Ringed Shank to help hold the nails in place
- Ring Shank Nails hold **40% Better** than compared to Smooth Shank Nails of the same size
- Compatible with Bostitch, Makita, Senco, Hitachi and Grip Rite 15 Degree Coil Siding/Fencing Nailers
- Not for use in cedar and where surface rust is unacceptable

\*\* May come in Electro-Galvanized

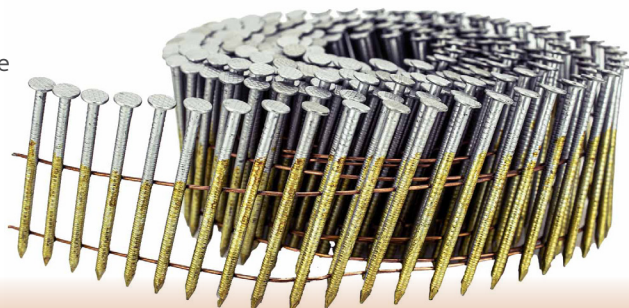
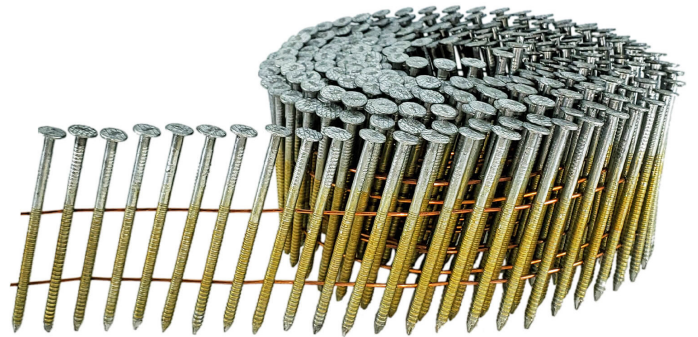
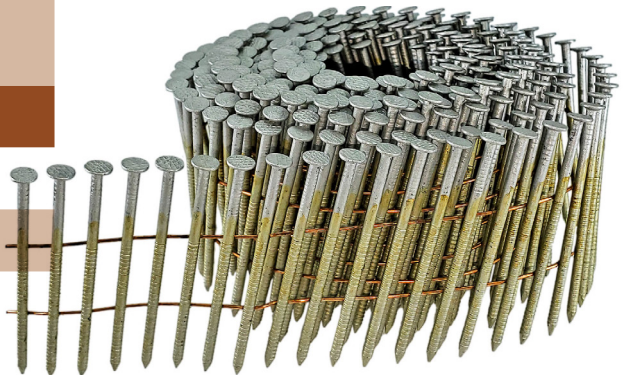

# NAILS

## 21 Degree Plastic Strip Collated Framing Nails

SIZE	QUANTITY
2-3/8" X .113" (8D)	FULL BOX ~5000 COUNT
3" X .120" (10D)	FULL BOX ~4000 COUNT
3" X .131" (10D)	FULL BOX ~4000 COUNT
3" X .120" (10D) RING SHANK	FULL BOX ~4000 COUNT

- **2-3/8" x .131 (8d) (Cooler)** for building crates and pallets, framing and subfloors - nails are thinner and slightly tapered
- **3" x .120 (10d)" and 3 x.131 (10d)** Plastic Strip Vinyl Coated - interior use not for ACQ Lumber
- 10d nails with a smooth shank, vinyl coated framing nails for common carpentry and construction projects
- Vinyl coating helps drive the nail into the wood with less effort and holds nails firmly
- **3" x .120 (10D) Ring Shank**, Plastic Strip, Hot Galvanized Vinyl Coated Nail for general construction and roofing
- Galvanized Ring Shank Nails can be used for both Interior and Exterior Work
- Ring Shank nails hold the nail in place by wedging the nail into the fiber of the board - 40% better holding ability

All 21 degree nails have round full head compared to typical 30 degree nails with a clipped head

All Styles are Compatible with Grip-Rite®, Hitachi®, Bostitch® and Makita® 21 Degree Nailers

*Check local ordinance for nail requirements. Meets or exceeds ASTM standards*





# NAILS

## Plastic Cap Ring Shank Roofing Nail

SIZE	QUANTITY
3 INCH	FULL BOX ~2000 COUNT

- Plastic Cap Ring Shank Nail designed to hold materials with superior holding power
- These nails are used for many different applications from roofing to house wrap
- Apply these nails to hold down roofing felt - keep it in place before roofing material is applied
- Also good for sheathing, vapor barriers, underlayment, sound proof materials and insulation
- Electro-Galvanized to resist rust and corrosion with plastic cap that resists moisture buildup



## Galvanized Roofing Nails

SIZE	QUANTITY
7/8 INCH	1 POUND ~290 COUNT
7/8 INCH	5 POUND ~1,433 COUNT
7/8 INCH	FULL BOX ~14,330 COUNT
1 INCH	1 POUND ~261 COUNT
1 INCH	5 POUNDS ~1,266 COUNT
1 INCH	FULL BOX ~12,660 COUNT

- These roofing screws are manufactured from Galvanized Steel to prevent rust and corrosion
- Smooth shank electro-galvanized meets ASTM F1667 standards
- Used for asphalt shingles and to fasten roof tiles, roofing felt and sheet metal



## HAVE QUESTIONS? NEED ANSWERS?

E-mail: [tom@jakesales.com](mailto:tom@jakesales.com)  
Phone: (406) 752-5253  
Website: [jakesales.com](http://jakesales.com)



# NAILS

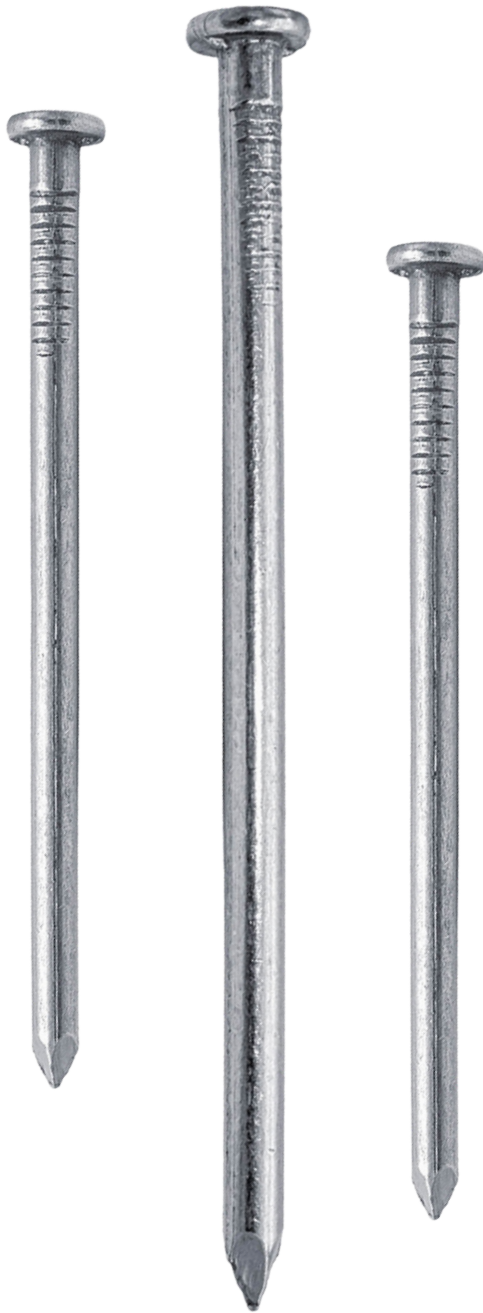

## Bright Common Nails General Purpose / Construction Fasteners

SIZE	QUANTITY
2-1/2" 8D	1 POUND ~ 97 COUNT
2-1/2" 8D	5 POUNDS ~ 485 COUNT
2-1/2" 8D	50 POUNDS ~ 4850 COUNT
3" 10D	1 POUND ~ 64 COUNT
3" 10D	5 POUNDS ~ 320 COUNT
3" 10D	50 POUNDS ~ 3200 COUNT
3-1/2" 16D	1 POUND ~ 47 COUNT
3-1/2" 16D	5 POUNDS ~ 235 COUNT
3-1/2" 16D	50 POUNDS ~ 2350 COUNT
4" 20D	1 POUND ~ 30 COUNT
4" 20D	5 POUNDS ~ 150 COUNT
4" 20D	50 POUNDS ~ 1500 COUNT
4-1/2" 30D	1 POUND ~ 22 COUNT
4-1/2" 30D	5 POUNDS ~ 110 COUNT
4-1/2" 30D	50 POUNDS ~ 1100 COUNT
5" 40D	1 POUND ~ 19 COUNT
5" 40D	5 POUNDS ~ 95 COUNT
5" 40D	50 POUNDS ~ 950 COUNT

- Bright Common Nail is a strong general purpose fastener for various projects
- Bright Finish Common Nails are usually used for interior wood work where corrosion is not a issue
- Good nails for projects including general construction, framing, structural work and roof trusses
- Common nails are able to carry more load than a Box nail due to it's heavier design and shank size
- Used in projects where you are looking for usability and strength and not appearance

**FREE  
SHIPPING\***



**\*USUALLY WITHIN 24 HOURS!**  
(EXCLUDES WEEKENDS, HOLIDAYS, SPECIAL ORDERS)



# NAILS

## Bright Finish - Finish Nails

SIZE	QUANTITY
1-1/2" 4D	1 POUND ~642 COUNT
1-1/2" 4D	5 POUNDS ~ 3210 COUNT
1-1/2" 4D	50 POUNDS ~ 32,100 COUNT
2" 6D	1 POUND ~ 225 COUNT
2" 6D	5 POUNDS ~ 1125 COUNT
2" 6D	50 POUNDS ~ 11,250 COUNT
2-1/2" 8D	1 POUND ~ 79 COUNT
2-1/2" 8D	5 POUNDS ~ 395 COUNT
2-1/2" 8D	50 POUNDS ~ 3950 COUNT

- Finish Nails are used for "finishing" projects and are non-structural in nature
- Common uses for a finish nail are installing crown molding, baseboards, paneling and other projects
- Usually installed by placing head of nail below surface of trim and then filling hole with putty
- Bright Finish finish nails are not recommended for exterior applications
- Small size of nail shaft helps prevent splitting wood



**HAVE QUESTIONS?  
NEED ANSWERS?**

E-mail: [tom@jakesales.com](mailto:tom@jakesales.com)  
Phone: (406) 752-5253  
Website: [jakesales.com](http://jakesales.com)

**Jake Sales**

[www.jakesales.com](http://www.jakesales.com)

# NAILS



## Ring Shank Nails (Spike, Common, Pole Barn)

SIZE	QUANTITY
5 INCH POLE BARN	1 POUND ~28 COUNT
5 INCH POLE BARN	5 POUNDS ~140 COUNT
5 INCH POLE BARN	FULL BOX ~1400 COUNT
5 INCH COMMON BRIGHT	50 COUNT
5 INCH COMMON BRIGHT	FULL BOX ~848 COUNT
1/4" X 6" COMMON	50 COUNT
1/4" X 6" COMMON	FULL BOX ~477 COUNT
5/16" X 7" SPIKE	50 COUNT
5/16" X 7" SPIKE	FULL BOX ~292 COUNT
5/16" X 8" SPIKE	50 COUNT
5/16" X 8" SPIKE	FULL BOX ~255 COUNT

• Order 2 or more Full Box Ring Shank Nails and **Save 5%**

- Ring Shank - Spike Nails for framing, carpentry, general construction or roofing applications
- Used for landscaping timbers, railroad ties, pole barns and load bearing structures
- These nails do not remove easy - best used on building permanent structures
- Ring shank nails, often used with softer woods like plywood, siding and shingles, provide a tighter, more permanent grip than smooth-shank nails.

## Sinker Framing Nails - Vinyl Coated

SIZE	QUANTITY
2-3/8" 8D	1 POUND ~ 141 COUNT
2-3/8" 8D	5 POUNDS ~ 705 COUNT
2-3/8" 8D	50 POUNDS ~ 7050 COUNT
3-1/8" 12D	1 POUND ~ 76 COUNT
3-1/8" 12D	5 POUNDS ~ 380 COUNT
3-1/8" 12D	50 POUNDS ~ 3800 COUNT
3-1/4" 16D	1 POUND ~ 61 COUNT
3-1/4" 16D	5 POUNDS ~ 305 COUNT
3-1/4" 16D	50 POUNDS ~ 3050 COUNT

- General Home construction, remodeling, general carpentry vinyl coated nails
- Used for interior framing and structural fastening, not recommended for exterior use
- Not for use when fastening treated lumber products where corrosion protection is needed
- Nails are vinyl coated to allow for holding power with smooth shank and for easier driving
- Flat checkered head type to prevent hammer from slipping off
- Drive head manufactured to install flush with lumber



# HALF PALLET • PALLET & TRUCKLOAD DISCOUNTS

AVAILABLE ON SELECTED ITEMS

PLEASE CALL US  
FOR ADDITIONAL INFORMATION

406-752-5253





**HAVE QUESTIONS?  
NEED ANSWERS?**

If there is anything  
we can assist you with,  
please feel free to call

**(406) 752-5253**

Monday - Friday,  
8am-4pm, Mountain Time

or

E-mail: [tom@jakesales.com](mailto:tom@jakesales.com)



We are constantly updating and revising our inventory and this catalog may not reflect all of those changes. Product availability & quantity discounts subject to change without notice. Please visit our websites for a more complete picture of all we have to offer.

